



# TDA9899

Multistandard hybrid IF processing including car mobile

Rev. 03 — 15 January 2008

Product data sheet

## 1. General description

---

The Integrated Circuit (IC) is suitable for Intermediate Frequency (IF) processing including global multistandard Analog TV (ATV), Digital Video Broadcast (DVB) and mono FM radio using only 1 IC and 1 to 3 fixed Surface Acoustic Waves (SAWs) (application dependent).

## 2. Features

---

### 2.1 General

- 5 V supply voltage
- I<sup>2</sup>C-bus control over all functions
- Four I<sup>2</sup>C-bus addresses provided; selection by programmable Module Address (MAD)
- Three I<sup>2</sup>C-bus voltage level supported; selection via pin BVS
- Separate gain controlled amplifiers with input selector and conversion for incoming IF [analog Vision IF (VIF) or Sound IF (SIF) or Digital TV (DTV)] allows the use of different filter shapes and bandwidths
- All conventional ATV standards applicable by using DTV bandwidth window [Band-Pass (BP)] filter
- Easy to use default settings for almost every standard provided, selectable via I<sup>2</sup>C-bus
- Two 4 MHz reference frequency stages; the first one operates either as crystal oscillator or as optional signal input, the second one either as external signal input or as buffered reference frequency output
- Stabilizer circuit for ripple rejection and to achieve constant output signals
- Smallest size, simplest application
- ElectroStatic Discharge (ESD) protection for all pins

### 2.2 Analog TV processing

- Gain controlled wide-band VIF amplifier; AC-coupled
- Multistandard true synchronous demodulation with active carrier regeneration: very linear demodulation, good intermodulation figures, reduced harmonics and excellent pulse response
- Internal Nyquist slope processing; switch-off able for alternative use of inexpensive Nyquist slope SAW filter with additive video noise improvement
- Separate passive video detector; monitor output for antenna diversity applications
- Gated phase detector for L and L-accent standards
- Fully integrated VIF Voltage-Controlled Oscillator (VCO), alignment-free, frequencies switchable for all negative and positive modulated standards via I<sup>2</sup>C-bus

- VIF Automatic Gain Control (AGC) detector for gain control; operating as a peak sync detector for negative modulated signals and as a peak white detector for positive modulated signals
- Optimized AGC modes for negative modulation; e.g. very fast reaction time for VIF and SIF
- External VIF AGC access for car mobile applications; enable function via control port
- Precise fully digital Automatic Frequency Control (AFC) detector with 4-bit Digital-to-Analog Converter (DAC); AFC bits can be read-out via I<sup>2</sup>C-bus
- High precise Tuner AGC (TAGC) TakeOver Point (TOP) for negative modulated standards; TOP adjust via I<sup>2</sup>C-bus
- TAGC TOP for positive standards and Received Signal Strength Indication (RSSI); adjustable via I<sup>2</sup>C-bus or alternatively by potentiometer
- Fully integrated Sound Carrier (SC) trap for any ATV standard (SC at 4.5 MHz, 5.5 MHz, 6.0 MHz and 6.5 MHz)
- SIF AGC for gain controlled SIF amplifier and high-performance single-reference Quasi Split Sound (QSS) mixer
- True Split Sound (TSS) mode; picture carrier independent sound demodulation for car mobile applications
- Fully integrated sound BP filter supporting any ATV standard
- Optional use of external FM sound BP filter
- AM sound demodulation for L and L-accent standard
- Alignment-free selective FM Phase-Locked Loop (PLL) demodulator with high linearity and low noise; external FM input
- Weak Audio Frequency Processing (WAFP) in the event of FM audio; audio gain and bandwidth dependent on received signal quality
- VIF AGC voltage monitor output or port function
- VIF AFC current or tuner, SIF or FM AGC voltage or WAFP voltage monitor output
- Buffered SIF wide-band output, gain controlled by internal SIF AGC
- 2nd SIF output, gain controlled by internal SIF AGC or by internal FM carrier AGC for Digital Signal Processor (DSP)
- Fully integrated BP filter for 2nd SIF at 4.5 MHz, 5.5 MHz, 6.0 MHz or 6.5 MHz

### 2.3 Digital TV processing

- Applicable for terrestrial and cable TV reception
- 70 dB variable gain wide-band IF amplifier (AC-coupled)
- Gain control via external control voltage (0 V to 3 V)
- 2 V (p-p) differential low IF (downconverted) output or 1 V (p-p) 1st IF output for direct Analog-to-Digital Converter (ADC) interfacing
- DVB downconversion with integrated selectivity for Low IF (LIF)/Zero IF (ZIF)
- Integrated anti-aliasing tracking low-pass filter
- Fully integrated synthesizer controlled oscillator with excellent phase noise performance
- Synthesizer frequencies for a wide range of world wide DVB standards (for IF center frequencies of 34.5 MHz, 36 MHz, 44 MHz and 57 MHz)
- All DVB bandwidth ranges supported (including ZIF I/Q)
- TAGC detector for independent tuner gain control loop applications

- TAGC operating as peak detector, fast reaction time due to additional speed-up detector
- Port function
- TAGC voltage monitor output

## 2.4 Dual mode

- Fully performed DTV processing and additional ATV video signal processing in parallel, but with reduced performance, for very fast channel scan
- VIF AGC voltage monitor output or port function
- VIF AFC current monitor output or TAGC voltage output

## 2.5 FM radio mode

- Gain controlled wide-band Radio IF (RIF) amplifier; AC-coupled
- Buffered RIF amplifier wide-band output, gain controlled by internal RIF AGC
- Fully integrated BP filter for 2nd RIF at 4.5 MHz, 5.5 MHz, 6.0 MHz, 6.5 MHz or 10.7 MHz
- 2nd RIF output, gain controlled by internal RIF AGC or by internal FM carrier AGC for DSP
- Alignment-free selective FM PLL demodulator with high linearity and low noise
- Precise fully digital AFC detector with 4-bit DAC; AFC bits read-out via I<sup>2</sup>C-bus
- Weak signal FM audio frequency processing
- Port function
- Radio AFC current or tuner, RIF or FM AGC voltage or WAFC voltage monitor output

## 3. Applications

- Analog and digital TV front-end applications for TV sets, recording applications, car mobile and personal computer cards

## 4. Quick reference data

**Table 1. Quick reference data**

$V_P = 5\text{ V}$ ;  $T_{amb} = 25\text{ }^\circ\text{C}$ .

Symbol	Parameter	Conditions	Min	Typ	Max	Unit
$V_P$	supply voltage		[1] 4.5	5.0	5.5	V
$I_P$	supply current		-	-	190	mA
<b>Analog TV signal processing</b>						
<b>Video part</b>						
$V_{i(IF)(RMS)}$	RMS IF input voltage	lower limit at -1 dB video output signal	-	60	100	$\mu\text{V}$
$G_{VIF(cr)}$	control range VIF gain		60	66	-	dB
$f_{VIF}$	VIF frequency	see <a href="#">Table 26</a>	-	-	-	MHz
$\Delta f_{VIF(dah)}$	digital acquisition help VIF frequency window	related to $f_{VIF}$				
		all standards except M/N	-	$\pm 2.3$	-	MHz
		M/N standard	-	$\pm 1.8$	-	MHz

**Table 1. Quick reference data ...continued**

$V_P = 5\text{ V}$ ;  $T_{amb} = 25\text{ }^\circ\text{C}$ .

Symbol	Parameter	Conditions	Min	Typ	Max	Unit
$V_{o(\text{video})(\text{p-p})}$	peak-to-peak video output voltage	see <a href="#">Figure 8</a> positive or negative modulation; normal mode and sound carrier on	[2] 1.7	2.0	2.3	V
		trap bypass mode and sound carrier off	[3] -	1.1	-	V
$G_{\text{dif}}$	differential gain	"ITU-T J.63 line 330" B/G standard	[2][4] -	-	5	%
		L standard	-	-	7	%
$\varphi_{\text{dif}}$	differential phase	"ITU-T J.63 line 330" B/G standard	[2][4] -	2	4	deg
		L standard	-	2	4	deg
$B_{\text{video}(-3\text{dB})}$	-3 dB video bandwidth	trap bypass mode and sound carrier off; AC load: $C_L < 20\text{ pF}$ , $R_L > 1\text{ k}\Omega$	[3] 6	8	-	MHz
$\alpha_{\text{SC1}}$	first sound carrier attenuation	M/N standard; $f = f_{\text{SC1}} = 4.5\text{ MHz}$ ; see <a href="#">Figure 20</a>	[3] 38	-	-	dB
		B/G standard; $f = f_{\text{SC1}} = 5.5\text{ MHz}$ ; see <a href="#">Figure 22</a>	[3] 35	-	-	dB
$(\text{S/N})_w$	weighted signal-to-noise ratio	normal mode and sound carrier on; B/G standard; 50 % grey video signal; unified weighting filter ("ITU-T J.61"); see <a href="#">Figure 19</a>	[2][5] 53	57	-	dB
$\text{PSRR}_{\text{CVBS}}$	power supply ripple rejection on pin CVBS	normal mode and sound carrier on; $f_{\text{ripple}} = 70\text{ Hz}$ ; video signal; grey level; positive and negative modulation; see <a href="#">Figure 9</a>	[2] 14	20	-	dB
$\Delta I_{\text{AFC}}/\Delta f_{\text{VIF}}$	change of AFC current with VIF frequency	AFC TV mode	[6] 0.85	1.05	1.25	$\mu\text{A/kHz}$
<b>Audio part</b>						
$V_{o(\text{AF})(\text{RMS})}$	RMS AF output voltage	FM: QSS or TSS mode; 27 kHz FM deviation; 50 $\mu\text{s}$ de-emphasis	430	540	650	mV
		AM: 54 % modulation	400	500	600	mV
THD	total harmonic distortion	FM: 50 $\mu\text{s}$ de-emphasis; FM deviation: for TV mode 27 kHz and for radio mode 22.5 kHz	-	0.15	0.50	%
		AM: 54 % modulation; BP on; see <a href="#">Figure 32</a>	-	0.5	1.0	%

**Table 1. Quick reference data ...continued**

$V_P = 5\text{ V}$ ;  $T_{amb} = 25\text{ }^\circ\text{C}$ .

Symbol	Parameter	Conditions	Min	Typ	Max	Unit
$f_{-3\text{dB(AF)}}$	AF cut-off frequency	W3[2] = 0; W3[4] = 0; without de-emphasis; FM window width = 237.5 kHz	80	100	-	kHz
$(S/N)_{\text{W(AF)}}$	AF weighted signal-to-noise ratio	"ITU-R BS.468-4"				
		FM: 27 kHz FM deviation; 50 $\mu\text{s}$ de-emphasis; vision carrier unmodulated; FM PLL only	48	56	-	dB
		AM: BP off	44	50	-	dB
PSRR	power supply ripple rejection	$f_{\text{ripple}} = 70\text{ Hz}$ ; see <a href="#">Figure 9</a>	14	20	-	dB
$V_{\text{O(RMS)}}$	RMS output voltage	IF intercarrier single-ended to GND; SC1 on; SC2 off	90	140	180	mV
		IF intercarrier single-ended to GND; L standard; without modulation; BP on; W7[5] = 0	45	70	90	mV
<i>FM sound part</i>						
$V_{\text{i(FM)(RMS)}}$	RMS FM input voltage	gain controlled operation; W1[1:0] = 10 or W1[1:0] = 11 or W1[1:0] = 01; see <a href="#">Figure 14</a>	2	-	300	mV
$\Delta I_{\text{AFC}}/\Delta f_{\text{RIF}}$	change of AFC current with RIF frequency	AFC radio mode	<a href="#">[6]</a> 0.85	1.05	1.25	$\mu\text{A/kHz}$
$\alpha_{\text{AM}}$	AM suppression	referenced to 27 kHz FM deviation; 50 $\mu\text{s}$ de-emphasis; AM: $f = 1\text{ kHz}$ ; $m = 54\%$	35	46	-	dB
<b>Digital TV signal processing</b>						
<b>Digital direct IF</b>						
$V_{\text{O(dif)(p-p)}}$	peak-to-peak differential output voltage	between pin OUT2A and pin OUT2B	<a href="#">[7]</a>			
		W4[7] = 0	-	1.0	1.1	V
		W4[7] = 1	-	0.50	0.55	V
$G_{\text{IF(max)}}$	maximum IF gain	output peak-to-peak level to input RMS level ratio	<a href="#">[8]</a> -	83	-	dB
$G_{\text{IF(cr)}}$	control range IF gain		<a href="#">[8]</a> 60	66	-	dB
PSRR	power supply ripple rejection	residual spurious at nominal differential output voltage dependent on power supply ripple	<a href="#">[8]</a>			
		$f_{\text{ripple}} = 70\text{ Hz}$	-	60	-	dB
		$f_{\text{ripple}} = 20\text{ kHz}$	-	60	-	dB
<b>Digital low IF</b>						
$V_{\text{O(dif)(p-p)}}$	peak-to-peak differential output voltage	between pin OUT1A and pin OUT1B; W4[7] = 0	<a href="#">[7]</a> -	2	-	V

**Table 1. Quick reference data ...continued**

$V_P = 5\text{ V}$ ;  $T_{amb} = 25\text{ }^\circ\text{C}$ .

Symbol	Parameter	Conditions	Min	Typ	Max	Unit
$G_{IF(max)}$	maximum IF gain	output peak-to-peak level to input RMS level ratio	[8] -	89	-	dB
$G_{IF(cr)}$	control range IF gain		[8] 60	66	-	dB
$f_{synth}$	synthesizer frequency	see <a href="#">Table 37</a> and <a href="#">Table 38</a>	-	-	-	MHz
$\varphi_{n(synth)}$	synthesizer phase noise	with 4 MHz crystal oscillator reference; $f_{synth} = 31\text{ MHz}$ ; $f_{IF} = 36\text{ MHz}$				
		at 1 kHz	[8] 89	99	-	dBc/Hz
		at 10 kHz	[8] 89	99	-	dBc/Hz
		at 100 kHz	[8] 98	102	-	dBc/Hz
		at 1.4 MHz	[8] 115	119	-	dBc/Hz
$\alpha_{ripple(pb)LIF}$	low IF pass-band ripple	6 MHz bandwidth	-	-	2.7	dB
		7 MHz bandwidth	-	-	2.7	dB
		8 MHz bandwidth	-	-	2.7	dB
$\alpha_{stpb}$	stop-band attenuation	8 MHz band; $f = 15.75\text{ MHz}$	30	40	-	dB
$\alpha_{image}$	image rejection	-10 MHz to 0 MHz; BP on	30	34	-	dB
C/N	carrier-to-noise ratio	at $f_o = 4.9\text{ MHz}$ ; $V_{i(IF)} = 10\text{ mV (RMS)}$ ; see <a href="#">Figure 38</a>	[8][9][10] 112	118	-	dBc/Hz

**Digital zero IF**

$V_{o(dif)(p-p)}$	peak-to-peak differential output voltage	between pin OUT1A and pin OUT1B or between pin OUT2A and pin OUT2B; $W4[7] = 0$	[7] -	2	-	V
$G_{IF(max)}$	maximum IF gain	output peak-to-peak level to input RMS level ratio	[8] -	89	-	dB
$G_{IF(cr)}$	control range IF gain		[8] 60	66	-	dB
$f_{synth}$	synthesizer frequency	see <a href="#">Table 37</a> and <a href="#">Table 38</a>	-	-	-	MHz
$\varphi_{n(synth)}$	synthesizer phase noise	with 4 MHz crystal oscillator reference; $f_{synth} = 31\text{ MHz}$ ; $f_{IF} = 36\text{ MHz}$				
		at 1 kHz	[8] 89	99	-	dBc/Hz
		at 10 kHz	[8] 89	99	-	dBc/Hz
		at 100 kHz	[8] 98	102	-	dBc/Hz
		at 1.4 MHz	[8] 115	119	-	dBc/Hz

**Reference frequency input from external source**

$f_{ref}$	reference frequency	$W7[7] = 0$	[11] -	4	-	MHz
$V_{ref(RMS)}$	RMS reference voltage	$W7[7] = 0$ ; see <a href="#">Figure 35</a> and <a href="#">Figure 47</a>	15	150	500	mV

- [1] Values of video and sound parameters can be decreased at  $V_P = 4.5\text{ V}$ .
- [2] AC load;  $C_L < 20\text{ pF}$  and  $R_L > 1\text{ k}\Omega$ . The sound carrier frequencies (depending on TV standard) are attenuated by the integrated sound carrier traps.
- [3] The sound carrier trap can be bypassed by setting the I<sup>2</sup>C-bus bit  $W2[0]$  to logic 0; see [Table 25](#). In this way the full composite video spectrum appears at pin CVBS. The video amplitude is reduced to 1.1 V (p-p).

- [4] Condition: luminance range (5 steps) from 0 % to 100 %. Measurement value is based on 4 of 5 steps.
- [5] Measurement using 200 kHz high-pass filter, 5 MHz low-pass filter and subcarrier notch filter ("ITU-T J.64").
- [6] To match the AFC output signal to different tuning systems a current output is provided. The test circuit is given in [Figure 18](#). The AFC steepness can be changed by resistors R1 and R2.
- [7] With single-ended load for  $f_{IF} < 45$  MHz  $R_L \geq 1$  k $\Omega$  and  $C_L \leq 5$  pF to ground and for  $f_{IF} = 45$  MHz to 60 MHz  $R_L = 1$  k $\Omega$  and  $C_L \leq 3$  pF to ground.
- [8] This parameter is not tested during production and is only given as application information.
- [9] Noise level is measured without input signal but AGC adjusted corresponding to the given input level.
- [10] Set with AGC nominal output voltage as reference. For C/N measurement switch input signal off.
- [11] The tolerance of the reference frequency determines the accuracy of VIF AFC, RIF AFC, FM demodulator center frequency, maximum FM deviation, sound trap frequency, LIF band-pass cut-off frequency and ZIF low-pass cut-off frequency as well as the accuracy of the synthesizer.

## 5. Ordering information

**Table 2. Ordering information**

Type number	Package		Version
	Name	Description	
TDA9899HL	LQFP48	plastic low profile quad flat package; 48 leads; body 7 × 7 × 1.4 mm	SOT313-2
TDA9899HN	HVQFN48	plastic thermal enhanced very thin quad flat package; no leads; 48 terminals; body 7 × 7 × 0.85 mm	SOT619-1





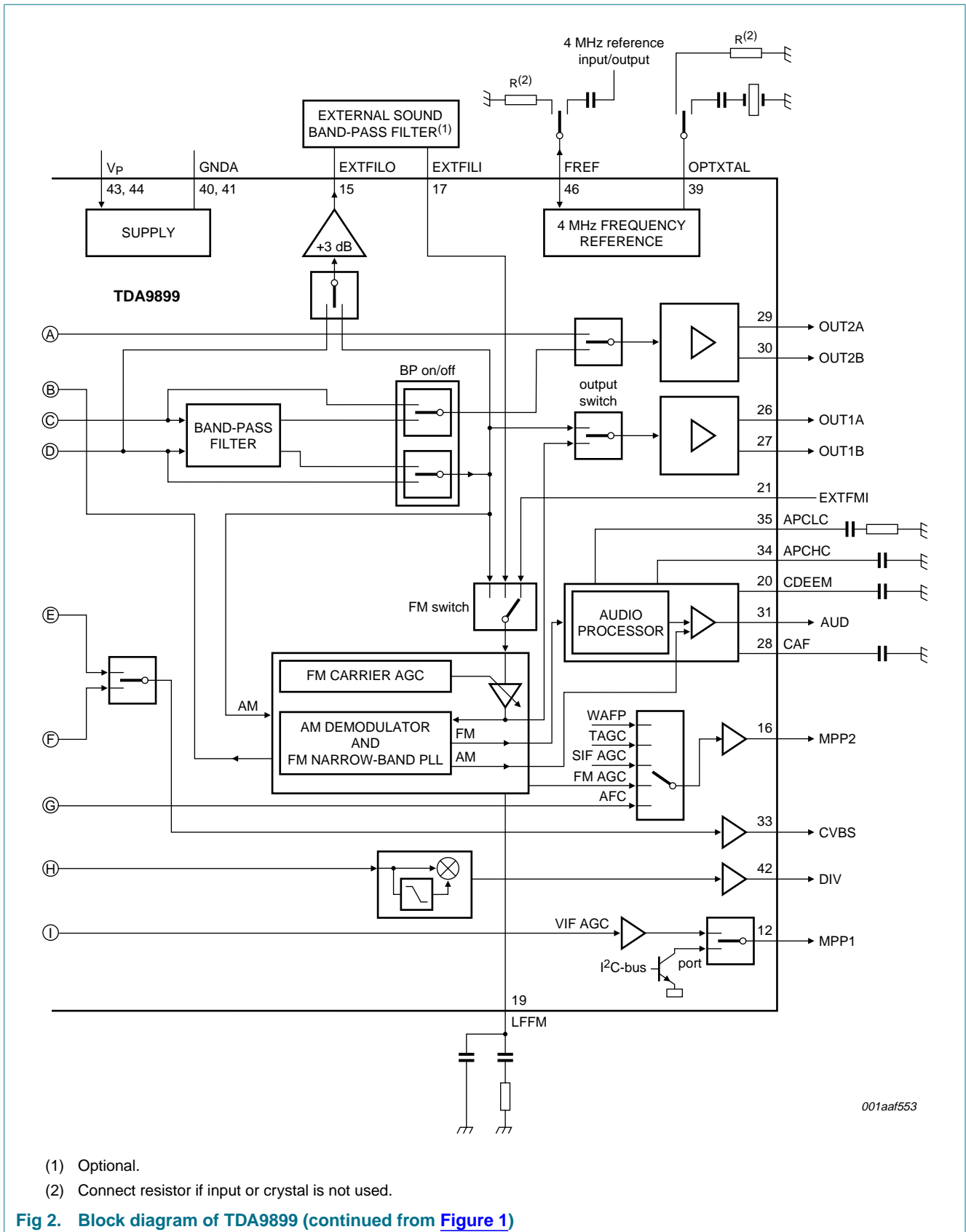

## 7. Pinning information

### 7.1 Pinning

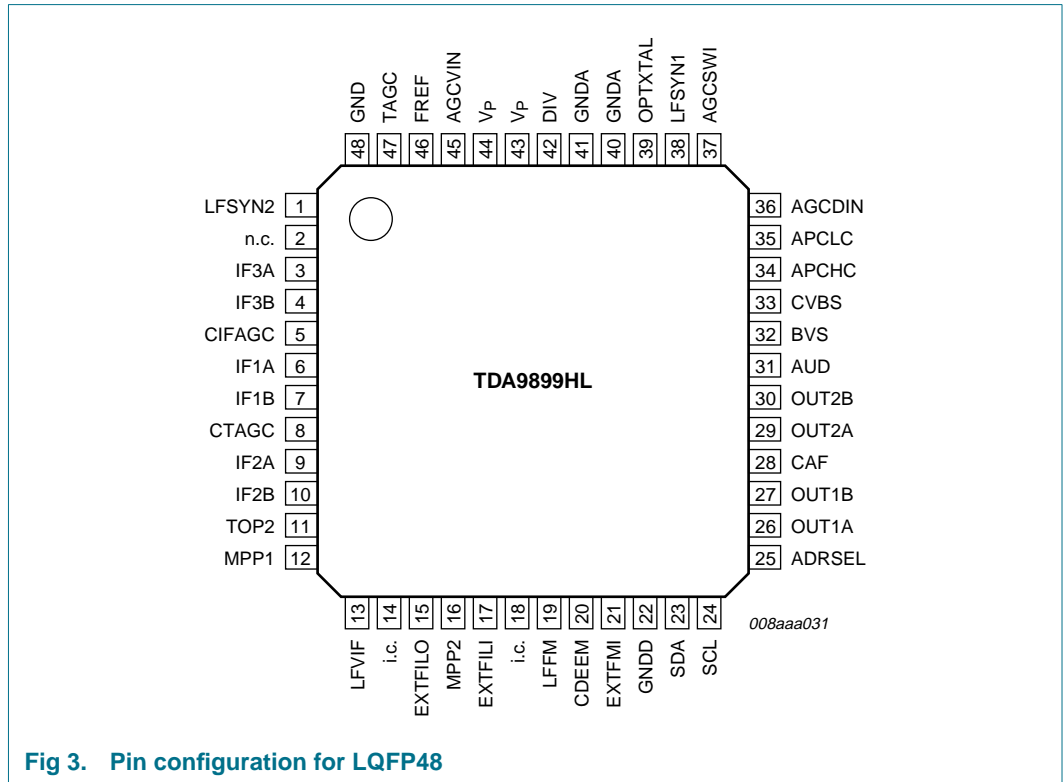

Fig 3. Pin configuration for LQFP48

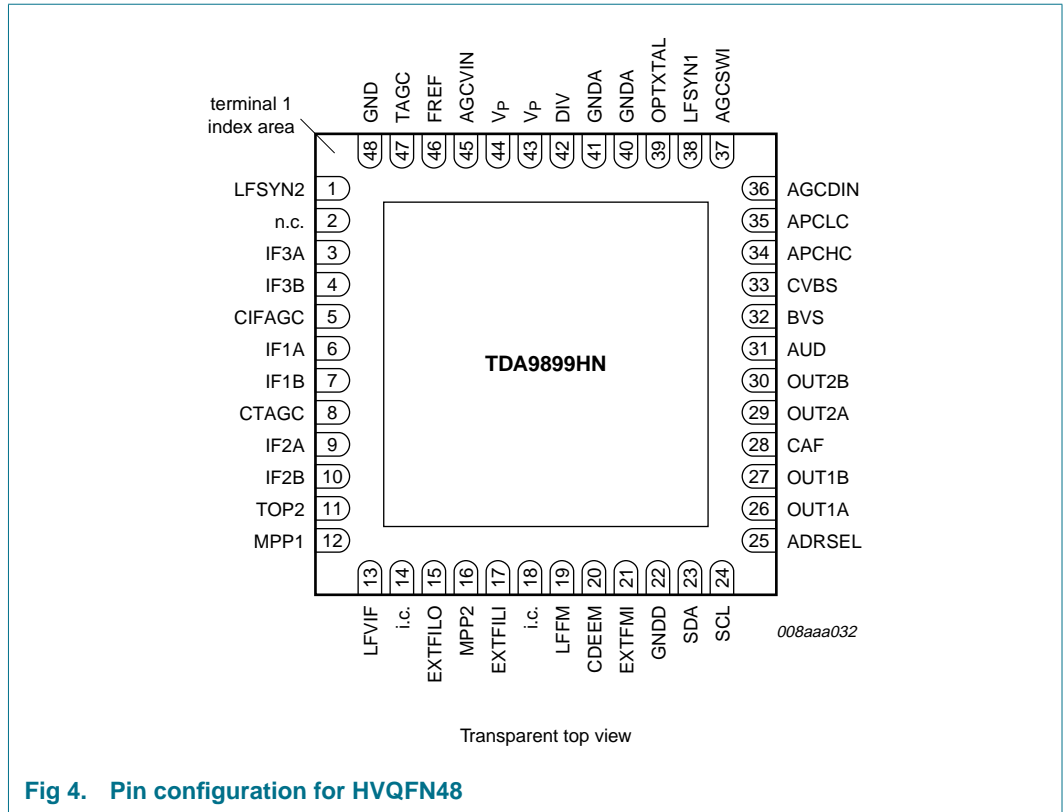

Fig 4. Pin configuration for HVQFN48

## 7.2 Pin description

Table 3. Pin description

Symbol	Pin	Description
LFSYN2	1	loop filter synthesizer 2 (conversion synthesizer)
n.c.	2	not connected
IF3A	3	IF symmetrical input 3 for sound
IF3B	4	
CIFAGC	5	IF AGC capacitor; L standard
IF1A	6	IF symmetrical input 1 for vision or digital
IF1B	7	
CTAGC	8	TAGC capacitor
IF2A	9	IF symmetrical input 2 for vision or digital
IF2B	10	
TOP2	11	TOP potentiometer for positive modulated standards and RSSI reference
MPP1	12	multipurpose pin 1: VIF AGC monitor output or port function
LRVIF	13	loop filter VIF PLL
i.c.	14	internally connected; connect to ground
EXTFILO	15	output to external filter
MPP2	16	multipurpose pin 2: SIF AGC or FM AGC or TAGC or VIF AFC or FM AFC or WAFP monitor output
EXTFILI	17	input from external filter

Table 3. Pin description ...continued

Symbol	Pin	Description
i.c.	18	internally connected; connect to ground
LFFM	19	loop filter FM PLL
CDEEM	20	de-emphasis capacitor
EXTFMI	21	external FM input
GNDD	22	digital ground
SDA	23	I <sup>2</sup> C-bus data input and output
SCL	24	I <sup>2</sup> C-bus clock input
ADRSEL	25	address select
OUT1A	26	zero IF I or low IF or 2nd sound intercarrier symmetrical output
OUT1B	27	
CAF	28	Direct Current (DC) decoupling capacitor
OUT2A	29	zero IF Q or 1st Digital IF (DIF) symmetrical output
OUT2B	30	
AUD	31	audio signal output
BVS	32	I <sup>2</sup> C-bus voltage select
CVBS	33	composite video signal output
APCHC	34	audio processing capacitor for high cut
APCLC	35	audio processing capacitor and resistor for low cut
AGCDIN	36	AGC input for DIF amplifier for e.g. input from channel decoder AGC
AGCSWI	37	AGC control switch
LFSYN1	38	loop filter synthesizer 1 (filter control synthesizer)
OPTXTAL	39	optional quartz input
GNDA	40	analog ground
GNDA	41	analog ground
DIV	42	diversity output
V <sub>P</sub>	43	supply voltage
V <sub>P</sub>	44	supply voltage
AGCVIN	45	AGC input for VIF amplifier
FREF	46	4 MHz reference input or output
TAGC	47	TAGC output
GND	48	ground; plateau connection

## 8. Functional description

### 8.1 IF input switch

Different signal bandwidth can be handled by using two signal processing chains with individual gain control.

Switch configuration allows independent selection of filter for analog VIF and for analog SIF (used at same time) or DIF.

The switch takes into account correct signal selection for TAGC in the event of VIF and DIF signal processing.

## 8.2 VIF demodulator

ATV demodulation using 6 MHz DVB window (band-pass) filter (for 6 MHz, 7 MHz or 8 MHz channel width).

IF frequencies adapted to enable the use of different filter configurations. The Nyquist processing is integrated.

For optional use of standard Nyquist filter the integrated Nyquist processing can be switched off.

Sideband switch supplies selection of lower or upper sideband (e.g. for L-accnt).

Equalizer provides optimum pulse response at different standards [e.g. to cope with higher demands for Liquid Crystal Display (LCD) TV].

Integrated sound traps.

Sound trap reference independent from received 2nd sound IF (reference taken from integrated reference synthesizer).

IF level selection provides an optimum adaptation of the demodulator to high linearity or low noise.

Separate passive video detector for monitoring the received IF level in combination with AGC hold mode for diversity application.

## 8.3 VIF AGC and tuner AGC

### 8.3.1 Mode selection of VIF AGC

Peak white AGC for positive modulation mode with adaptation for speed up and black level AGC (using proven system from TDA9886).

For negative modulation mode equal response times for increasing or decreasing input level (optimum for amplitude fading) **or** normal peak AGC **or** ultra fast peak AGC (for car mobile).

### 8.3.2 External VIF AGC control

AGC input for external control enabled via fast switching input (car mobile).

AGC hold mode (for diversity detection) via fast switching input (car mobile).

### 8.3.3 VIF AGC monitor

VIF AGC DC voltage monitor output (with expanded internal characteristic).

VIF AGC read out via I<sup>2</sup>C-bus (for IF level indication) with zero-calibration via TOP setting (TOP setting either via I<sup>2</sup>C-bus or via TOP potentiometer).

### 8.3.4 Tuner AGC

Independent integral tuner gain control loop (not nested with VIF AGC). Integral characteristic provides high control accuracy.

Accurate setting of tuner control onset (TOP) for integral tuner gain control loop via I<sup>2</sup>C-bus.

For L standard, TAGC remains VIF AGC nested, as from field experience in the past this narrow-band TAGC gives best performance.

Thus two switchable TAGC systems for negative/DIF and positive modulation implemented.

L standard TAGC output changed from current output to voltage output, as it is not necessary to adapt for other than 5 V tuner.

L standard tuner time constant switching integrated (= speed up function in the event of step into high input levels), to minimize external application.

For high TOP accuracy at L standard, additional adjustment via optional potentiometer or I<sup>2</sup>C-bus is provided.

Tuner AGC status bit provided. This function enables TOP alignment without need for TAGC voltage measurement (e.g. for TOP alignment in a complete set, where access to internal signals is not possible).

### 8.4 DIF/SIF FM and AM sound AGC

External AGC control input for DIF. DIF includes 1st IF, zero IF and low IF.

Integrated gain control loop for SIF.

Bandwidth of AGC control for FM SIF related to used SAW bandwidth.

Peak AGC control in the event of FM SIF.

Ultra fast SIF AGC time constant for mobile mode.

Slow average AGC control in the event of AM sound.

AM sound AGC related to AM sound carrier level.

Fast AM sound AGC in the event of fast VIF AGC (speed up).

SIF AGC DC voltage monitor output with expanded internal characteristic.

### 8.5 Frequency phase-locked loop for VIF

Basic function as previous TDA9887 design.

PLL gating mode for positive and negative modulation, optional.

PLL optimized for either overmodulation or strong multipath (car mobile).

## 8.6 DIF/SIF converter stage

Frequency conversion with sideband suppression.

Selection mode of upper or lower sideband for pass or suppression.

Suppression around zero for frequency conversion.

I/Q output mode for zero IF conversion.

Conversion mode selection via synthesizer for DIF, TSS and radio mode or via VIF Frequency Phase-Locked Loop (FPLL) for TV QSS sound (FM/AM).

External BP filter (e.g. for 4.5 MHz) for additional filtering, optional.

Bypass mode selection for use of external filter.

Integrated SIF BP tracking filter for chroma suppression.

Integrated tracking filters for LIF and ZIF.

Symmetrical output stages for DIF, ZIF and 2nd SIF.

Second narrow-band gain control loop for 2nd SIF via FM PLL.

## 8.7 Mono sound demodulator

### 8.7.1 Narrow-band FM PLL demodulation

Additional external input for either TV or radio intercarrier signal.

FM carrier selection independent from VIF trap, because VIF trap uses reference via synthesizer.

FM wide and ultra wide mode with adapted loop bandwidth and different selectable FM acquisition window widths to cope with FM overmodulation conditions.

### 8.7.2 AM sound demodulation

Passive AM sound detector.

L and L-accent standard without SAW switching (done by sideband selection of SIF converter).

## 8.8 Audio amplifier

Different gain settings for FM sound to adapt to different FM deviation.

Switchable de-emphasis for FM sound.

Automatic mute function when FM PLL is unlocked.

Forced mute function.

Weak signal processing for FM sound in the event of low or noisy FM carrier.

Weak signal processing includes noise dependent gain and bandwidth control.

Output amplifier for AM sound.

### 8.9 Synthesizer

In DIF mode, the synthesizer supports low and zero IF input frequencies for 34.5 MHz, 36 MHz, 44 MHz and 57 MHz center frequencies.

In TSS and radio mode, the synthesizer supports 2nd sound intercarrier conversion. A large set of synthesizer frequencies in steps of 0.5 MHz enables flexible combination of filter and 2nd IF frequencies.

Synthesizer loop internally adapted to divider ratio range for optimum phase noise requirement (loop bandwidth).

Synthesizer reference either via 4 MHz crystal or via an external source. Individual pins for crystal and external reference allows optimum interface definition and supports use of custom reference frequency offset.

Buffered reference frequency output optional via external reference pin.

### 8.10 I<sup>2</sup>C-bus transceiver and slave address

Four different I<sup>2</sup>C-bus device addresses to enable application with multi-IC use.

I<sup>2</sup>C-bus transceiver input ports can handle three different I<sup>2</sup>C-bus voltages.

Read-out functions as TDA9887 plus additional read out of VIF AGC and TAGC status.

**Table 4. Slave address detection**

Slave address	Selectable address bit		Pin ADRSEL
	A3	A0	
MAD1	0	1	GND
MAD2	0	0	V <sub>P</sub>
MAD3	1	1	resistor to GND
MAD4	1	0	resistor to V <sub>P</sub>

## 9. I<sup>2</sup>C-bus control

**Table 5. Slave addresses<sup>[1]</sup>**

Slave address		Bit							
Name	Value	A6	A5	A4	A3	A2	A1	A0	
MAD1	43h	1	0	0	0	0	1	1	
MAD2	42h	1	0	0	0	0	1	0	
MAD3	4Bh	1	0	0	1	0	1	1	
MAD4	4Ah	1	0	0	1	0	1	0	

[1] For MAD activation via pin ADRSEL: see [Table 4](#).



9.1 Read format

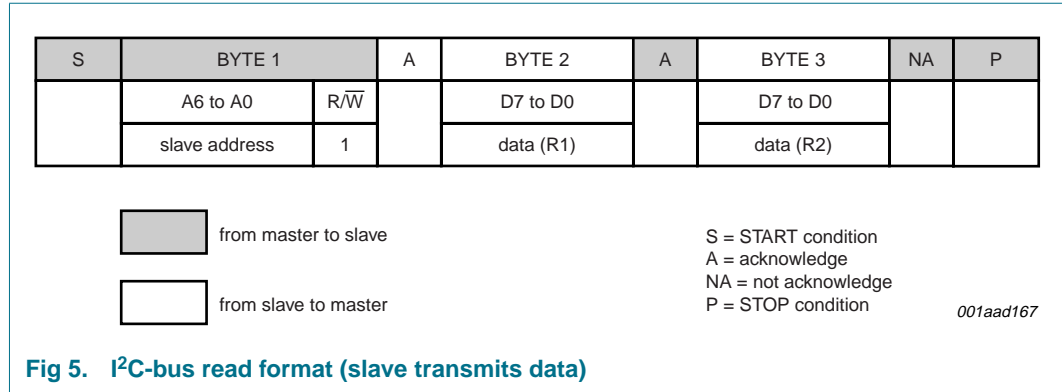

Fig 5. I<sup>2</sup>C-bus read format (slave transmits data)

Table 6. R1 - data read register 1 bit allocation

<b>7</b>	<b>6</b>	<b>5</b>	<b>4</b>	<b>3</b>	<b>2</b>	<b>1</b>	<b>0</b>
AFCWIN	reserved	CARRDET	AFC4	AFC3	AFC2	AFC1	PONR

Table 7. R1 - data read register 1 bit description

Bit	Symbol	Description
7	AFCWIN	AFC window <sup>[1]</sup>  1 = VCO in ±1.6 MHz AFC window <sup>[2]</sup> 1 = VCO in ±0.8 MHz AFC window <sup>[3]</sup> 0 = VCO out of ±1.6 MHz AFC window <sup>[2]</sup> 0 = VCO out of ±0.8 MHz AFC window <sup>[3]</sup>
6	-	reserved
5	CARRDET	FM carrier detection <sup>[4]</sup>  1 = detection (FM PLL is locked and level is less than 6 dB below gain controlled range of FM AGC) 0 = no detection
4 to 1	AFC[4:1]	automatic frequency control; see <a href="#">Table 8</a>
0	PONR	power-on reset  1 = after power-on reset or after supply breakdown 0 = after a successful reading of the status register

[1] If no IF input is applied, then bit AFCWIN can be logic 1 due to the fact that the VCO is forced to the AFC window border for fast lock-in behavior.

[2] All standards except M/N standard.

[3] M/N standard.

[4] Typical time constant of FM carrier detection is 50 ms. The minimal recommended wait time for read out is 80 ms.

**Table 8. Automatic frequency control bits<sup>[1]</sup>**

Bit				f <sup>[2]</sup>
AFC4	AFC3	AFC2	AFC1	
R1[4]	R1[3]	R1[2]	R1[1]	
0	1	1	1	≤ (f <sub>nom</sub> – 187.5 kHz)
0	1	1	0	f <sub>nom</sub> – 162.5 kHz
0	1	0	1	f <sub>nom</sub> – 137.5 kHz
0	1	0	0	f <sub>nom</sub> – 112.5 kHz
0	0	1	1	f <sub>nom</sub> – 87.5 kHz
0	0	1	0	f <sub>nom</sub> – 62.5 kHz
0	0	0	1	f <sub>nom</sub> – 37.5 kHz
0	0	0	0	f <sub>nom</sub> – 12.5 kHz
1	1	1	1	f <sub>nom</sub> + 12.5 kHz
1	1	1	0	f <sub>nom</sub> + 37.5 kHz
1	1	0	1	f <sub>nom</sub> + 62.5 kHz
1	1	0	0	f <sub>nom</sub> + 87.5 kHz
1	0	1	1	f <sub>nom</sub> + 112.5 kHz
1	0	1	0	f <sub>nom</sub> + 137.5 kHz
1	0	0	1	f <sub>nom</sub> + 162.5 kHz
1	0	0	0	≥ (f <sub>nom</sub> + 187.5 kHz)

[1] f<sub>nom</sub> is the nominal frequency.

[2] In ATV mode f means vision intermediate frequency; in radio mode f means radio intermediate frequency.

**Table 9. R2 - data read register 2 bit allocation**

7	6	5	4	3	2	1	0
reserved	TAGC	VAGC5	VAGC4	VAGC3	VAGC2	VAGC1	VAGC0

**Table 10. R2 - data read register 2 bit description**

Bit	Symbol	Description
7	-	reserved
6	TAGC	tuner AGC 1 = active 0 = inactive
5 to 0	VAGC[5:0]	AGC level detector; VIF AGC in ATV mode, SIF AGC in radio mode and DIF AGC in DTV mode; see <a href="#">Table 11</a>

Table 11. AGC bits (for corresponding AGC characteristic see [Figure 10](#))

Bit						Typical $\Delta V_{AGC(VIF)}$ (V)
VAGC5	VAGC4	VAGC3	VAGC2	VAGC1	VAGC0	
R2[5]	R2[4]	R2[3]	R2[2]	R2[1]	R2[0]	
1	1	1	1	1	1	0 (TOP) <sup>[1]</sup>
1	1	1	1	1	0	-0.04
1	1	1	1	0	1	-0.08
1	1	1	1	0	0	-0.12
1	1	1	0	1	1	-0.16
1	1	1	0	1	0	-0.20
1	1	1	0	0	1	-0.24
1	1	1	0	0	0	-0.28
1	1	0	1	1	1	-0.32
1	1	0	1	1	0	-0.36
1	1	0	1	0	1	-0.40
1	1	0	1	0	0	-0.44
1	1	0	0	1	1	-0.48
1	1	0	0	1	0	-0.52
1	1	0	0	0	1	-0.56
1	1	0	0	0	0	-0.60
1	0	1	1	1	1	-0.64
1	0	1	1	1	0	-0.68
1	0	1	1	0	1	-0.72
1	0	1	1	0	0	-0.76
1	0	1	0	1	1	-0.80
1	0	1	0	1	0	-0.84
1	0	1	0	0	1	-0.88
1	0	1	0	0	0	-0.92
1	0	0	1	1	1	-0.96
1	0	0	1	1	0	-1.00
1	0	0	1	0	1	-1.04
1	0	0	1	0	0	-1.08
1	0	0	0	1	1	-1.12
1	0	0	0	1	0	-1.16
1	0	0	0	0	1	-1.20
1	0	0	0	0	0	-1.24
0	1	1	1	1	1	-1.28
0	1	1	1	1	0	-1.32
0	1	1	1	0	1	-1.36
0	1	1	1	0	0	-1.40
0	1	1	0	1	1	-1.44
0	1	1	0	1	0	-1.48
0	1	1	0	0	1	-1.52

Table 11. AGC bits (for corresponding AGC characteristic see [Figure 10](#)) ...continued

Bit						Typical $\Delta V_{AGC(VIF)}$ (V)
VAGC5	VAGC4	VAGC3	VAGC2	VAGC1	VAGC0	
R2[5]	R2[4]	R2[3]	R2[2]	R2[1]	R2[0]	
0	1	1	0	0	0	-1.56
0	1	0	1	1	1	-1.60
0	1	0	1	1	0	-1.64
0	1	0	1	0	1	-1.68
0	1	0	1	0	0	-1.72
0	1	0	0	1	1	-1.76
0	1	0	0	1	0	-1.80
0	1	0	0	0	1	-1.84
0	1	0	0	0	0	-1.88
0	0	1	1	1	1	-1.92
0	0	1	1	1	0	-1.96
0	0	1	1	0	1	-2.00
0	0	1	1	0	0	-2.04
0	0	1	0	1	1	-2.08
0	0	1	0	1	0	-2.12
0	0	1	0	0	1	-2.16
0	0	1	0	0	0	-2.20
0	0	0	1	1	1	-2.24
0	0	0	1	1	0	-2.28
0	0	0	1	0	1	-2.32
0	0	0	1	0	0	-2.36
0	0	0	0	1	1	-2.40
0	0	0	0	1	0	-2.44
0	0	0	0	0	1	-2.48
0	0	0	0	0	0	-2.52

[1] The reference of 0 (TOP) can be adjusted via TOPPOS[4:0] (register W10; see [Table 51](#) and [Table 49](#)) or via potentiometer at pin TOP2.

## 9.2 Write format

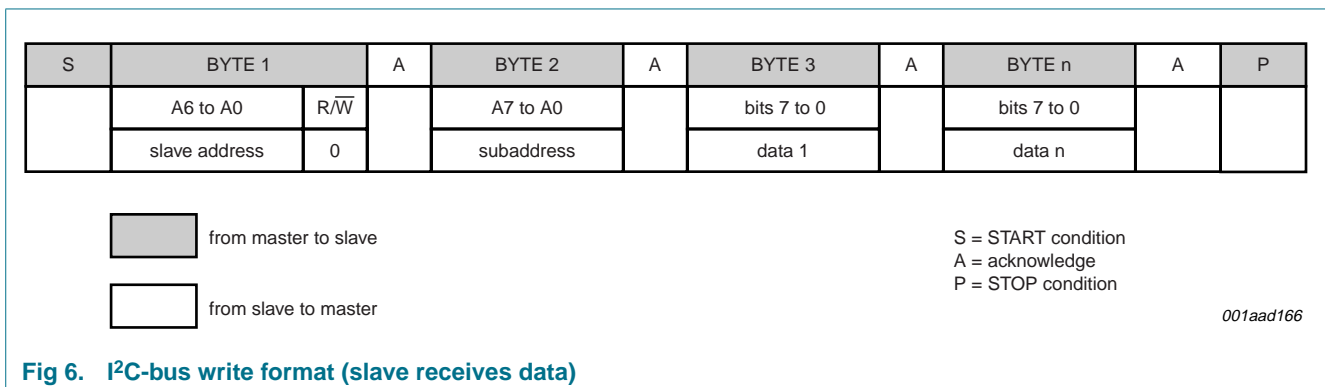

### 9.2.1 Subaddress

**Table 12. W0 - subaddress register bit allocation**

7	6	5	4	3	2	1	0
A7	A6	A5	A4	A3	A2	A1	A0

**Table 13. W0 - subaddress register bit description**

Bit	Symbol	Description
7 to 4	A[7:4]	has to be set to logic 0
3 to 0	A[3:0]	subaddress; see <a href="#">Table 14</a>

**Table 14. Subaddress control bits**

Bit				Mode
A3	A2	A1	A0	
0	0	0	0	subaddress for register W1
0	0	0	1	subaddress for register W2
0	0	1	0	subaddress for register W3
0	0	1	1	subaddress for register W4
0	1	0	0	subaddress for register W5
0	1	0	1	subaddress for register W6
0	1	1	0	subaddress for register W7
0	1	1	1	subaddress for register W8
1	0	0	0	subaddress for register W9
1	0	0	1	subaddress for register W10

**Table 15. I<sup>2</sup>C-bus write register overview<sup>[1]</sup>**

Register	7	6	5	4	3	2	1	0
W1 <sup>[2]</sup>	RADIO	STD1	STD0	TV2	TV1	DUAL	FM	EXTFIL
W2 <sup>[3]</sup>	MOD	STD4	STD3	STD2	SB	PLL	GATE	TRAP
W3 <sup>[4]</sup>	RESCAR	AMUTE	FMUTE	FMWIDE0	DEEMT	DEEM	AGAIN1	AGAIN0
W4 <sup>[5]</sup>	VIFLEVEL	BP	MPP2S1	MPP2S0	AGCSW	IFIN1	IFIN0	VIFIN
W5 <sup>[6]</sup>	FSFREQ1	FSFREQ0	SFREQ5	SFREQ4	SFREQ3	SFREQ2	SFREQ1	SFREQ0
W6 <sup>[7]</sup>	TAGC1	TAGC0	AGC2	AGC1	FMWIDE1	TWOFLO	AUDIOPRO	DIRECT
W7 <sup>[8]</sup>	FREFOUT	WAFP	SIFLEVEL	VIDLEVEL	OPSTATE	PORT	FILOUTBP	NYQOFF
W8 <sup>[9]</sup>	0	0	0	0	EASY3	EASY2	EASY1	EASY0
W9 <sup>[10]</sup>	DAGCSLOPE	TAGCIS	TAGCTC	TOPNEG4	TOPNEG3	TOPNEG2	TOPNEG1	TOPNEG0
W10 <sup>[11]</sup>	0	0	XPOTPOS	TOPPOS4	TOPPOS3	TOPPOS2	TOPPOS1	TOPPOS0

[1] The register setting after power-on is not specified.

[2] See [Table 17](#) for detailed description of W1.

[3] See [Table 25](#) for detailed description of W2.

[4] See [Table 29](#) for detailed description of W3.

[5] See [Table 31](#) for detailed description of W4.

[6] See [Table 36](#) for detailed description of W5.

[7] See [Table 40](#) for detailed description of W6.

- [8] See [Table 43](#) for detailed description of W7.
- [9] See [Table 45](#) for detailed description of W8.
- [10] See [Table 48](#) for detailed description of W9.
- [11] See [Table 51](#) for detailed description of W10.

### 9.2.2 Description of data bytes

**Table 16. W1 - data write register bit allocation**

7	6	5	4	3	2	1	0
RADIO	STD1	STD0	TV2	TV1	DUAL	FM	EXTFIL

**Table 17. W1 - data write register bit description**

Bit	Symbol	Description
7	RADIO	FM mode 1 = radio 0 = ATV/DTV
6 and 5	STD[1:0]	2nd sound IF; see <a href="#">Table 18</a> , <a href="#">Table 19</a> and <a href="#">Table 20</a>
4 and 3	TV[2:1]	TV mode 00 = DTV and ZIF 01 = DTV and LIF 10 = ATV and TSS 11 = ATV and QSS
2	DUAL	ATV and DTV dual mode for channel search; see <a href="#">Table 23</a> 1 = dual (TV2 = 0) 0 = normal
1 and 0	FM and EXTFIL	FM and output switching; see <a href="#">Table 22</a>

**Table 18. Intercarrier sound BP and FM PLL frequency select for ATV, QSS mode<sup>[1]</sup>**

Bit							f <sub>FMPLL</sub> (MHz)	Sound BP
RADIO	MOD	STD1	STD0	FSFREQ1	FSFREQ0	TV1		
W1[7]	W2[7]	W1[6]	W1[5]	W5[7]	W5[6]	W1[3]		
0	1	0	0	X	X	1	4.5	M/N standard
0	1	0	1	X	X	1	5.5	B/G standard
0	1	1	0	X	X	1	6.0	I standard
0	1	1	1	X	X	1	6.5	D/K standard
0	0	1	1	X	X	1	off	L/L-accent standard

[1] For description of bit MOD refer to [Table 25](#) and bits FSFREQ[1:0] are described in [Table 36](#).

Table 19. Intercarrier sound BP and FM PLL frequency select for ATV, TSS mode<sup>[1]</sup>

Bit							f <sub>FMPLL</sub> (MHz)	Sound BP; recommended for
RADIO	MOD	STD1	STD0	FSFREQ1	FSFREQ0	TV1		
W1[7]	W2[7]	W1[6]	W1[5]	W5[7]	W5[6]	W1[3]		
0	1	0	1	0	0	0	5.5	M/N standard
0	1	0	1	0	1	0	5.5	B/G standard
0	1	0	1	1	0	0	5.5	I standard
0	1	0	1	1	1	0	5.5	D/K standard
0	0	1	1	X	X	0	off	L/L-accent standard

[1] For description of bit MOD refer to [Table 25](#) and bits FSFREQ[1:0] are described in [Table 36](#).

Table 20. Intercarrier sound BP and FM PLL frequency select for radio, QSS mode<sup>[1]</sup>

Bit							f <sub>FMPLL</sub> (MHz)	Sound BP
RADIO	MOD	STD1	STD0	FSFREQ1	FSFREQ0	TV1		
W1[7]	W2[7]	W1[6]	W1[5]	W5[7]	W5[6]	W1[3]		
1	1	X	X	0	0	0	4.5	M/N standard
1	1	X	X	0	1	0	5.5	B/G standard
1	1	X	X	1	0	0	6.0	I standard
1	1	X	X	1	1	0	6.5	D/K standard
1	0	X	X	X	X	0	10.7	RADIO

[1] For description of bit MOD refer to [Table 25](#) and bits FSFREQ[1:0] are described in [Table 36](#).

Table 21. Second sound IF selection for 10.7 MHz<sup>[1]</sup>

Bit			f <sub>FMPLL</sub> (MHz)
BP	MOD	RADIO	
W4[6]	W2[7]	W1[7]	
0	0	1	10.7

[1] For description of bit MOD refer to [Table 25](#) and for BP refer to [Table 31](#).

Table 22. 2nd intercarrier and sound input and output switching

MOD	FM	EXTFIL	Mode	Input signal selection (input switch)	Signal at OUT1A and OUT1B (output switch)	Mono sound demodulation
W2[7]	W1[1]	W1[0]				
1	0	0	FM sound	internal	internal BP via FM AGC	internal BP
1	0	1	FM sound	EXTFILI	internal BP	external BP
1	1	0	FM sound	EXTFMI	internal BP	external input
1	1	1	FM sound	EXTFILI	external BP via FM AGC	external BP
0	0	0	AM sound	not used		
0	0	1	AM sound	-	internal BP	internal BP
0	1	0	AM sound	-	internal BP	internal BP
0	1	1	AM sound	EXTFILI	external BP	internal BP

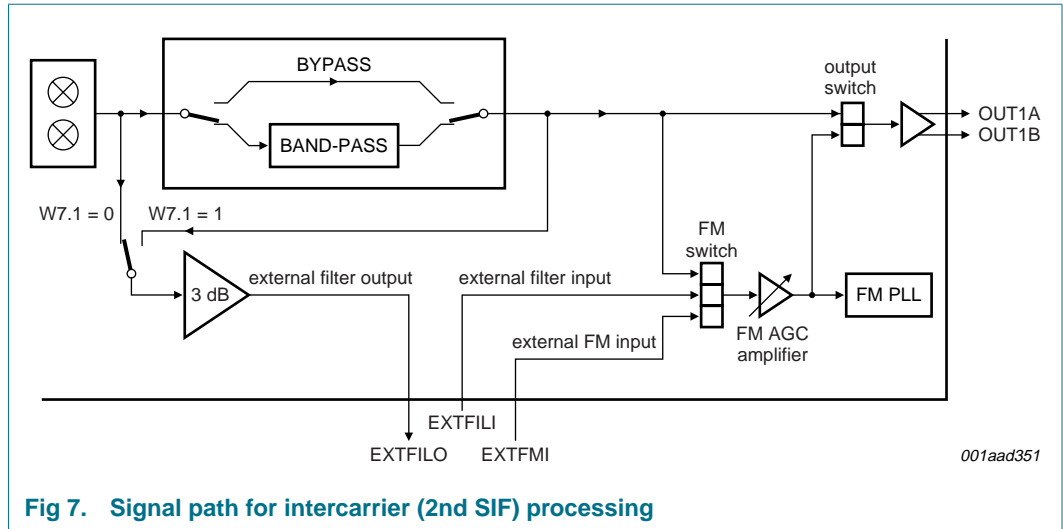

Fig 7. Signal path for intercarrier (2nd SIF) processing

Table 23. Dual mode options

Bit				Output mode
TV2	TV1	DIRECT	DUAL	
W1[4]	W1[3]	W6[0]	W1[2]	
X	X	X	0	all normal mode functions (ATV <b>OR</b> DTV)
0	X	1	1	analog CVBS at pin CVBS <b>AND</b> direct 1st DIF at pins OUT2A and OUT2B
0	0	0	1	analog CVBS at pin CVBS <b>AND</b> digital zero IF I/Q at pins OUT1A, OUT1B and OUT2A, OUT2B
0	1	0	1	analog CVBS at pin CVBS <b>AND</b> digital low IF at pins OUT1A and OUT1B



Table 24. W2 - data write register bit allocation

7	6	5	4	3	2	1	0
MOD	STD4	STD3	STD2	SB	PLL	GATE	TRAP

Table 25. W2 - data write register bit description

Bit	Symbol	Description
7	MOD	modulation 1 = negative; FM mono sound at ATV and dual mode 0 = positive; AM mono sound at ATV and dual mode
6 to 4	STD[4:2]	vision IF; see <a href="#">Table 26</a>
3	SB	sideband for sound IF and digital low IF 1 = upper 0 = lower
2	PLL	operating modes; see <a href="#">Table 27</a>
1	GATE	PLL gating 1 = on 0 = off
0	TRAP	sound trap 1 = on 0 = bypass

Table 26. Vision IF

Bit					f <sub>VIF</sub> (MHz)		Sideband
	NYQOFF	MOD	STD4	STD3	STD2	TV1 = 0 (TSS)	
W7[0]	W2[7]	W2[6]	W2[5]	W2[4]			
X	0	0	0	0	38.0	38.0	low
X	0	0	0	1	38.5	38.375	low
X	0	0	1	0	39.0	38.875	low
X	0	0	1	1	39.5	39.875	low
X	0	1	0	0	32.0	32.25	high
0	0	1	0	1	32.5	32.625	high
1	0	1	0	1	32.5	33.9	-
X	0	1	1	0	33.0	33.125	high
X	0	1	1	1	33.5	33.625	high
X	1	0	0	0	38.0	38.0	low
X	1	0	0	1	38.5	38.375	low
X	1	0	1	0	39.0	38.875	low
X	1	0	1	1	39.5	39.875	low
X	1	1	0	0	46.5	45.75	low
X	1	1	0	1	59.5	58.75	low
X	1	1	1	0	46.0	46.25	low
X	1	1	1	1	59.0	59.25	low

**Table 27. VIF PLL gating and detector mode**

Bit		Gating and detector mode
MOD	PLL	
W2[7]	W2[2]	
0	0	0 % gating in positive modulation mode (W2[1] = 1)
0	1	36 % gating in positive modulation mode (W2[1] = 1)
1	0	$\pi$ mode on; optimized for overmodulation in negative modulation mode; $f_{PC} = 0 \text{ kHz} \pm 187.5 \text{ kHz}$
1	1	$\pi$ mode off; optimized for multipath in negative modulation mode; $f_{PC} = 0 \text{ kHz} \pm 187.5 \text{ kHz}$

**Table 28. W3 - data write register bit allocation**

7	6	5	4	3	2	1	0
RESCAR	AMUTE	FMUTE	FMWIDE0	DEEMT	DEEM	AGAIN1	AGAIN0

**Table 29. W3 - data write register bit description**

Bit	Symbol	Description
7	RESCAR	video gain correction for residual carrier 1 = 20 % residual carrier 0 = 10 % residual carrier
6	AMUTE	auto mute 1 = on 0 = off
5	FMUTE	forced mute 1 = on 0 = off
4	FMWIDE0	FM window (W6[3] = 0) 1 = 475 kHz; normal FM phase detector steepness 0 = 237.5 kHz; high FM phase detector steepness
3	DEEMT	de-emphasis time 1 = 50 $\mu\text{s}$ 0 = 75 $\mu\text{s}$
2	DEEM	de-emphasis 1 = on 0 = off
1 and 0	AGAIN[1:0]	audio gain 00 = 0 dB 01 = -6 dB 10 = -12 dB (only for FM mode) 11 = -18 dB (only for FM mode)

**Table 30. W4 - data write register bit allocation**

7	6	5	4	3	2	1	0
VIFLEVEL	BP	MPP2S1	MPP2S0	AGCSW	IFIN1	IFIN0	VIFIN

**Table 31. W4 - data write register bit description**

Bit	Symbol	Description
7	VIFLEVEL	control of internal VIF mixer input level (W1[4] = 1) and OUT1/OUT2 output level; see <a href="#">Table 32</a> 1 = reduced 0 = normal
6	BP	SIF/DIF BP 1 = on (bit W6[0] = 0; see <a href="#">Table 40</a> ) 0 = bypass
5 and 4	MPP2S[1:0]	AGC or AFC output; see <a href="#">Table 33</a>
3	AGCSW	VIF AGC switch state; see <a href="#">Table 34</a> 1 = VIF AGC hold (for diversity detection) 0 = VIF AGC external
2 and 1	IFIN[1:0]	DIF/SIF input 00 = IF1A/B input 01 = IF3A/B input 10 = not used 11 = IF2A/B input
0	VIFIN	VIF input 1 = IF1A/B input 0 = IF2A/B input

Table 32. List of output signals at OUT1 and OUT2

Bit					Output signal at	
TV2	TV1	DIRECT	FM	EXTFIL	OUT1A, OUT1B	OUT2A, OUT2B
W1[4]	W1[3]	W6[0]	W1[1]	W1[0]		
0	0	0	X	X	zero IF I	zero IF Q
0	1	0	X	X	low IF	off
0	X	1	X	X	off	direct IF
1	X	1	0	0	intercarrier <sup>[1]</sup>	SIF <sup>[2]</sup>
1	X	1	0	1	intercarrier <sup>[3]</sup>	SIF <sup>[2]</sup>
1	X	1	1	0	intercarrier <sup>[3]</sup>	SIF <sup>[2]</sup>
1	X	1	1	1	intercarrier <sup>[1]</sup>	SIF <sup>[2]</sup>
1	X	0	0	0	intercarrier <sup>[1]</sup>	off
1	X	0	0	1	intercarrier <sup>[3]</sup>	off
1	X	0	1	0	intercarrier <sup>[3]</sup>	off
1	X	0	1	1	intercarrier <sup>[1]</sup>	off

[1] Inter-carrier output level based on wide-band AGC of SIF amplifier.

[2] SIF output level based on wide-band AGC of SIF amplifier.

[3] Inter-carrier output level based on narrow-band AGC of FM amplifier.

Table 33. Output mode at pin MPP2 for ATV; dual or radio mode

Bit				Pin MPP2 output mode
WAFP	RADIO	MPP2S1	MPP2S0	
W7[6]	W1[7]	W4[5]	W4[4]	
0	X	0	0	gain control voltage of FM PLL
0	X	0	1	gain control voltage of SIF amplifier
0	X	1	0	TAGC monitor voltage
0	0	1	1	AFC current output, VIF PLL
0	1	1	1	AFC current output, radio mode
1	X	0	0	voltage output of weak audio signal detector

Table 34. Control function of bit AGCSW

W4[3] (AGCSW)	V <sub>AGCSW</sub>	Function
0	< 1 V	VIF AGC from internal
0	> 2 V	VIF AGC from pin AGCVIN
1	< 1 V	VIF AGC is <b>not</b> on hold
1	> 2 V	VIF AGC is on hold

Table 35. W5 - data write register bit allocation

7	6	5	4	3	2	1	0
FSFREQ1	FSFREQ0	SFREQ5	SFREQ4	SFREQ3	SFREQ2	SFREQ1	SFREQ0

Table 36. W5 - data write register bit description<sup>[1]</sup>

Bit	Symbol	Description
7 and 6	FSFREQ[1:0]	DTV filter or sound trap selection for video <b>ATV</b> ; sound trap; TV2 = 1 00 = M/N standard (4.5 MHz) 01 = B/G standard (5.5 MHz) 10 = I standard (6.0 MHz) 11 = D/K and L/L-accent standard (6.5 MHz) <b>DTV (zero IF)</b> ; low-pass cut-off frequency; TV2 = 0 and TV1 = 0 00 = 3.0 MHz 01 = 3.5 MHz 10 = 4.0 MHz 11 = not used <b>DTV (low IF)</b> ; upper BP cut-off frequency; TV2 = 0 and TV1 = 1 00 = 7.0 MHz 01 = 8.0 MHz 10 = 9.0 MHz 11 = not used
5 to 0	SFREQ[5:0]	synthesizer frequencies; see <a href="#">Table 37</a> and <a href="#">Table 38</a>

[1] For bit description of TV1 and TV2 see [Table 16](#) W1[3] and W1[4] and [Table 17](#).

Table 37. DIF/SIF synthesizer frequencies (using bit TWOFLO = 0)

Bit						f <sub>synth</sub> (MHz)
SFREQ5	SFREQ4	SFREQ3	SFREQ2	SFREQ1	SFREQ0	
W5[5]	W5[4]	W5[3]	W5[2]	W5[1]	W5[0]	
1	1	1	1	1	1	22.0
1	1	1	1	1	0	22.5
1	1	1	1	0	1	23.0
1	1	1	1	0	0	23.5
1	1	1	0	1	1	24.0
1	1	1	0	1	0	24.5
1	1	1	0	0	1	25.0
1	1	1	0	0	0	25.5
1	1	0	1	1	1	26.0
1	1	0	1	1	0	26.5
1	1	0	1	0	1	27.0
1	1	0	1	0	0	27.5
1	1	0	0	1	1	28.0
1	1	0	0	1	0	28.5
1	1	0	0	0	1	29.0
1	1	0	0	0	0	29.5
1	0	1	1	1	1	30.0
1	0	1	1	1	0	30.5
1	0	1	1	0	1	31.0
1	0	1	1	0	0	31.5
1	0	1	0	1	1	32.0
1	0	1	0	1	0	32.5
1	0	1	0	0	1	33.0
1	0	1	0	0	0	33.5
1	0	0	1	1	1	34.0
1	0	0	1	1	0	34.5
1	0	0	1	0	1	35.0
1	0	0	1	0	0	35.5
1	0	0	0	1	1	36.0
1	0	0	0	1	0	36.5
1	0	0	0	0	1	37.0
1	0	0	0	0	0	37.5
0	1	1	1	1	1	38.0
0	1	1	1	1	0	38.5
0	1	1	1	0	1	39.0
0	1	1	1	0	0	39.5
0	1	1	0	1	1	40.0
0	1	1	0	1	0	40.5
0	1	1	0	0	1	41.0

Table 37. DIF/SIF synthesizer frequencies (using bit TWOFLO = 0) ...continued

Bit						f <sub>synth</sub> (MHz)
SFREQ5	SFREQ4	SFREQ3	SFREQ2	SFREQ1	SFREQ0	
W5[5]	W5[4]	W5[3]	W5[2]	W5[1]	W5[0]	
0	1	1	0	0	0	41.5
0	1	0	1	1	1	42.0
0	1	0	1	1	0	42.5
0	1	0	1	0	1	43.0
0	1	0	1	0	0	43.5
0	1	0	0	1	1	44.0
0	1	0	0	1	0	44.5
0	1	0	0	0	1	45.0
0	1	0	0	0	0	45.5
0	0	1	1	1	1	46.0
0	0	1	1	1	0	46.5
0	0	1	1	0	1	47.0
0	0	1	1	0	0	47.5
0	0	1	0	1	1	48.0
0	0	1	0	1	0	48.5
0	0	1	0	0	1	49.0
0	0	1	0	0	0	49.5
0	0	0	1	1	1	50.0
0	0	0	1	1	0	50.5
0	0	0	1	0	1	51.0
0	0	0	1	0	0	51.5
0	0	0	0	1	1	52.0
0	0	0	0	1	0	52.5
0	0	0	0	0	1	53.0
0	0	0	0	0	0	53.5

Table 38. DIF/SIF synthesizer frequency for zero IF Japan (using bit TWOFLO = 1)

Bit						f <sub>synth</sub> (MHz)
SFREQ5	SFREQ4	SFREQ3	SFREQ2	SFREQ1	SFREQ0	
W5[5]	W5[4]	W5[3]	W5[2]	W5[1]	W5[0]	
1	1	0	0	1	0	57

**Table 39. W6 - data write register bit allocation**

7	6	5	4	3	2	1	0
TAGC1	TAGC0	AGC2	AGC1	FMWIDE1	TWOFLO	AUDIOPRO	DIRECT

**Table 40. W6 - data write register bit description**

Bit	Symbol	Description
7 and 6	TAGC[1:0]	tuner AGC mode <sup>[1]</sup> 00 = TAGC integral loop mode; all currents off 01 = TAGC integral loop mode; source current off 10 = TAGC integral loop mode 11 = TAGC derived from IF AGC; recommended for positive modulated signals
5 and 4	AGC[2:1]	AGC mode and behavior; see <a href="#">Table 41</a>
3	FMWIDE1	FM window 1 = 1 MHz 0 = see <a href="#">Table 29</a> bit FMWIDE0
2	TWOFLO	synthesizer frequency selection 1 = zero IF Japan mode (57 MHz) 0 = synthesizer mode
1	AUDIOPRO	audio processing (weak signal handling) 1 = on 0 = bypass
0	DIRECT	direct IF at DTV mode; TV2 = 0 <sup>[2]</sup> 1 = direct IF output 0 = zero IF or low IF output direct SIF at ATV or radio mode; TV2 = 1 or RADIO = 1 <sup>[2]</sup> 1 = buffered SIF output at pins OUT2A and OUT2B 0 = pins OUT2A and OUT2B switched off

[1] In integral TAGC loop mode the pin TAGC provides sink and source currents for control. TakeOver Point (TOP) is set via register W9 TOPNEG[4:0].

[2] For bit description refer to [Table 16](#) and [Table 17](#).

**Table 41. AGC mode and behavior**

Bit		VIF AGC; MOD = 1 <sup>[1]</sup>	SIF AGC
AGC2	AGC1		
W6[5]	W6[4]		
0	0	normal	normal
0	1	off (minimum gain)	off (minimum gain)
1	0	fast	normal
1	1	2nd fast	fast

[1] For bit description of MOD refer to [Table 24](#) W2[7] and [Table 25](#).



**Table 42. W7 - data write register bit allocation**

7	6	5	4	3	2	1	0
FREFOUT	WAFP	SIFLEVEL	VIDLEVEL	OPSTATE	PORT	FILOUTBP	NYQOFF

**Table 43. W7 - data write register bit description**

Bit	Symbol	Description
7	FREFOUT	reference frequency output 1 = pin FREF works as reference frequency output <sup>[1]</sup> 0 = pin FREF works as quartz oscillator or reference frequency input
6	WAFP	weak FM AF processing control voltage at pin MPP2; see <a href="#">Table 33</a>
5	SIFLEVEL	SIF level reduction 1 = internal SIF level is reduced by 6 dB (only for AM sound) 0 = internal SIF level is normal
4	VIDLEVEL	video level reduction 1 = internal video level is reduced by 6 dB 0 = internal video level is normal
3	OPSTATE	output state; PORT = 1 1 = output port is HIGH (external pull-up resistor needed) 0 = output port is LOW
2	PORT	port or VIF AGC monitor 1 = pin MPP1 is logic output port; level depends on OPSTATE 0 = pin MPP1 is VIF AGC monitor output; independent on OPSTATE
1	FILOUTBP	external filter output signal source; see <a href="#">Figure 7</a> 1 = signal for external filter is obtained behind internal BP filter 0 = signal for external filter is obtained behind SIF mixer
0	NYQOFF	internal Nyquist processing 1 = internal Nyquist processing off 0 = internal Nyquist processing on

[1] Pin OPTXTAL wired as quartz oscillator or used as reference frequency input.

**Table 44. W8 - data write register bit allocation**

7	6	5	4	3	2	1	0
0	0	0	0	EASY3	EASY2	EASY1	EASY0

**Table 45. W8 - data write register bit description**

Bit	Symbol	Description
7 to 4	-	0 = fixed value
3 to 0	EASY[3:0]	easy setting; see <a href="#">Table 46</a>

Table 46. Easy setting (to be used for fixed bit set-up only)<sup>[1]</sup>

Bit				Mode or standard	Name	Bit definition (hexadecimal)						
EASY3	EASY2	EASY1	EASY0			W1	W2	W3	W4	W5	W6	W7
W8[3]	W8[2]	W8[1]	W8[0]									
0	0	0	0	off	-	-	-	-	-	-	-	-
0	0	0	1	-	-	-	-	-	-	-	-	-
0	0	1	0	-	-	-	-	-	-	-	-	-
0	0	1	1	-	-	-	-	-	-	-	-	-
0	1	0	0	-	-	-	-	-	-	-	-	-
0	1	0	1	I 6.0	ES2	58	B1	CC	60	80	80	0C
0	1	1	0	B/G 5.5	ES3	38	B1	4C	60	40	80	0C
0	1	1	1	direct IF	ES4	08	E1	64	62	00	81	08
1	0	0	0	M Japan 4.5	ES5	18	F1	44	73	00	80	08
1	0	0	1	LIF 6/36	ES6	28	88	60	61	AD	00	0C
1	0	1	0	-	-	-	-	-	-	-	-	-
1	0	1	1	D/K 6.5	ES8	78	B1	4C	70	C0	80	0C
1	1	0	0	radio 5.5	ES9	BB	B8	40	26	6B	00	04
1	1	0	1	-	-	-	-	-	-	-	-	-
1	1	1	0	L 6.5	ES11	79	33	00	60	C0	C0	0C
1	1	1	1	-	-	-	-	-	-	-	-	-

[1] Access to register W1 to W6 after selection of an easy setting mode would require a transfer of all W1 to W6 register data.

Table 47. W9 - data write register bit allocation

7	6	5	4	3	2	1	0
DAGCSLOPE	TAGCIS	TAGCTC	TOPNEG4	TOPNEG3	TOPNEG2	TOPNEG1	TOPNEG0

Table 48. W9 - data write register bit description

Bit	Symbol	Description
7	DAGCSLOPE	AGCDIN input characteristic; see <a href="#">Figure 46</a> 1 = high voltage for high gain 0 = low voltage for high gain
6	TAGCIS	tuner AGC IF input 1 = inverse to VIF input 0 = aligned to VIF input
5	TAGCTC	tuner AGC time constant 1 = 2nd mode 0 = normal
4 to 0	TOPNEG[4:0]	TOP adjustment for integral loop mode; see <a href="#">Table 49</a>

**Table 49. Tuner takeover point adjustment bits W9[4:0]**

Bit					TOP adjustment (dB $\mu$ V)
TOPNEG4	TOPNEG3	TOPNEG2	TOPNEG1	TOPNEG0	
W9[4]	W9[3]	W9[2]	W9[1]	W9[0]	
1	1	1	1	1	98.2 typical
:	:	:	:	:	see <a href="#">Figure 12</a>
1	0	0	0	0	78.7 <sup>[1]</sup>
:	:	:	:	:	see <a href="#">Figure 12</a>
0	0	0	0	0	57.9 typical

[1] See [Table 55](#) for parameter tuner takeover point accuracy ( $\alpha_{acc(set)TOP}$ ).

**Table 50. W10 - data write register bit allocation**

7	6	5	4	3	2	1	0
0	0	XPOTPOS	TOPPOS4	TOPPOS3	TOPPOS2	TOPPOS1	TOPPOS0

**Table 51. W10 - data write register bit description**

Bit	Symbol	Description
7 and 6	-	0 = fixed value
5	XPOTPOS	TOP derived from IF AGC via I <sup>2</sup> C-bus or potentiometer 1 = TOP adjustment by external potentiometer at pin TOP2 0 = see <a href="#">Table 52</a>
4 to 0	TOPPOS[4:0]	TOP adjustment for TAGC derived from IF AGC; see <a href="#">Table 52</a>

**Table 52. Tuner takeover point adjustment bits W10[4:0]**

Bit					TOP adjustment (dB $\mu$ V)
TOPPOS4	TOPPOS3	TOPPOS2	TOPPOS1	TOPPOS0	
W10[4]	W10[3]	W10[2]	W10[1]	W10[0]	
1	1	1	1	1	99 typical
:	:	:	:	:	see <a href="#">Figure 12</a>
1	0	0	0	0	81 <sup>[1]</sup>
:	:	:	:	:	see <a href="#">Figure 12</a>
0	0	0	0	0	61 typical

[1] See [Table 55](#) for parameter tuner takeover point accuracy ( $\alpha_{acc(set)TOP2}$ ).

## 10. Limiting values

**Table 53. Limiting values**

In accordance with the Absolute Maximum Rating System (IEC 60134).

Symbol	Parameter	Conditions	Min	Max	Unit	
$V_P$	supply voltage		-	5.5	V	
$V_n$	voltage on any other pin	all pins except ground	0	$V_P$	V	
$t_{sc}$	short-circuit time	to ground or $V_P$	-	10	s	
$T_{stg}$	storage temperature		-40	+150	°C	
$T_{amb}$	ambient temperature		-20	+70	°C	
$T_{case}$	case temperature	TDA9899HL (LQFP48)	-	105	°C	
		TDA9899HN (HVQFN48)	-	115	°C	
$V_{esd}$	electrostatic discharge voltage	human body model	[1]	-	±3000	V
		machine model	[2]	-	±300	V

[1] Class 2 according to JESD22-A114.

[2] Class B according to EIA/JESD22-A115.

## 11. Thermal characteristics

**Table 54. Thermal characteristics**

Symbol	Parameter	Conditions	Typ	Unit
$R_{th(j-a)}$	thermal resistance from junction to ambient	in free air; 2 layer board		
		TDA9899HL (LQFP48)	67	K/W
		TDA9899HN (HVQFN48)	48	K/W
$R_{th(j-c)}$	thermal resistance from junction to case			
		TDA9899HL (LQFP48)	19	K/W
		TDA9899HN (HVQFN48)	10	K/W

## 12. Characteristics

### 12.1 Analog TV signal processing

**Table 55. Characteristics**

$V_P = 5\text{ V}$ ;  $T_{amb} = 25\text{ °C}$ ; see [Table 26](#) for input frequencies; B/G standard is used for the specification ( $f_{PC} = 38.375\text{ MHz}$ ;  $f_{SC} = 32.875\text{ MHz}$ ;  $PC / SC = 13\text{ dB}$ ;  $f_{AF} = 400\text{ Hz}$ ); input level  $V_{i(IF)} = 10\text{ mV (RMS)}$  (sync level for B/G; peak white level for L); IF input from  $50\ \Omega$  via broadband transformer 1 : 1; video modulation: Vestigial SideBand (VSB); residual carrier for B/G is 10 % and for L is 3 %; video signal in accordance with "ITU-T J.63 line 17 and line 330" or "NTC-7 Composite"; internal Nyquist slope switched on ( $W7[0] = 0$ ); not dual mode; measurements taken in test circuit of [Figure 49](#); unless otherwise specified.

Symbol	Parameter	Conditions	Min	Typ	Max	Unit
<b>Supply; pin <math>V_P</math></b>						
$V_P$	supply voltage	[1]	4.5	5.0	5.5	V
$I_P$	supply current		-	-	190	mA

**Table 55. Characteristics ...continued**

$V_P = 5\text{ V}$ ;  $T_{amb} = 25\text{ }^\circ\text{C}$ ; see [Table 26](#) for input frequencies; B/G standard is used for the specification ( $f_{PC} = 38.375\text{ MHz}$ ;  $f_{SC} = 32.875\text{ MHz}$ ;  $PC / SC = 13\text{ dB}$ ;  $f_{AF} = 400\text{ Hz}$ ); input level  $V_{i(IF)} = 10\text{ mV (RMS)}$  (sync level for B/G; peak white level for L); IF input from  $50\ \Omega$  via broadband transformer 1 : 1; video modulation: Vestigial SideBand (VSB); residual carrier for B/G is 10 % and for L is 3 %; video signal in accordance with "ITU-T J.63 line 17 and line 330" or "NTC-7 Composite"; internal Nyquist slope switched on ( $W7[0] = 0$ ); not dual mode; measurements taken in test circuit of [Figure 49](#); unless otherwise specified.

Symbol	Parameter	Conditions	Min	Typ	Max	Unit
<b>Power-on reset</b>						
$V_{P(POR)}$	power-on reset supply voltage	for start of reset at decreasing supply voltage	[2] 2.5	3.0	3.5	V
		for end of reset at increasing supply voltage; I <sup>2</sup> C-bus transmission enable	[2] -	3.3	4.4	V
<b>VIF amplifier; pins IF1A, IF1B, IF2A and IF2B</b>						
$V_I$	input voltage		-	1.95	-	V
$R_{i(dif)}$	differential input resistance		[3] -	2	-	k $\Omega$
$C_{i(dif)}$	differential input capacitance		[3] -	3	-	pF
$V_{i(IF)(RMS)}$	RMS IF input voltage	lower limit at -1 dB video output signal	-	60	100	$\mu\text{V}$
		upper limit at +1 dB video output signal	150	190	-	mV
		permissible overload	[4] -	-	320	mV
$\Delta G_{IF}$	IF gain variation	difference between picture and sound carrier; within AGC range; $\Delta f = 5.5\text{ MHz}$	-	0.7	-	dB
$G_{VIF(cr)}$	control range VIF gain		60	66	-	dB
$f_{-3dB(VIF)l}$	lower VIF cut-off frequency		-	15	-	MHz
$f_{-3dB(VIF)u}$	upper VIF cut-off frequency		-	80	-	MHz
<b>FPLL and true synchronous video demodulator[5]</b>						
$V_{LFVIF}$	voltage on pin L <sub>F</sub> VIF (DC)		0.9	-	3.6	V
$f_{VCO(max)}$	maximum VCO frequency	$f_{VCO} = 2f_{PC}$	120	140	-	MHz
$f_{VIF}$	VIF frequency	see <a href="#">Table 26</a>	-	-	-	MHz
$\Delta f_{VIF(dah)}$	digital acquisition help VIF frequency window	related to $f_{VIF}$				
		all standards except M/N	-	$\pm 2.3$	-	MHz
		M/N standard	-	$\pm 1.8$	-	MHz
$t_{acq}$	acquisition time	$B_{LF(-3dB)} = 70\text{ kHz}$	[6] -	-	30	ms
$V_{lock(min)(RMS)}$	RMS minimum lock-in voltage	measured on pins IF1A and IF1B or IF2A and IF2B; maximum IF gain; negative modulation mode $W2[7] = 1$ and PLL set to overmodulation mode $W2[2] = 0$ and $W2[1] = 0$	-	30	70	$\mu\text{V}$

**Table 55. Characteristics ...continued**

$V_P = 5\text{ V}$ ;  $T_{amb} = 25\text{ }^\circ\text{C}$ ; see [Table 26](#) for input frequencies; B/G standard is used for the specification ( $f_{PC} = 38.375\text{ MHz}$ ;  $f_{SC} = 32.875\text{ MHz}$ ;  $PC / SC = 13\text{ dB}$ ;  $f_{AF} = 400\text{ Hz}$ ); input level  $V_{i(IF)} = 10\text{ mV (RMS)}$  (sync level for B/G; peak white level for L); IF input from  $50\text{ }\Omega$  via broadband transformer 1 : 1; video modulation: Vestigial SideBand (VSB); residual carrier for B/G is 10 % and for L is 3 %; video signal in accordance with "ITU-T J.63 line 17 and line 330" or "NTC-7 Composite"; internal Nyquist slope switched on ( $W7[0] = 0$ ); not dual mode; measurements taken in test circuit of [Figure 49](#); unless otherwise specified.

Symbol	Parameter	Conditions	Min	Typ	Max	Unit	
$T_{cy(dah)}$	digital acquisition help cycle time		-	64	-	$\mu\text{s}$	
$t_w(dah)$	digital acquisition help pulse width		64	-	-	$\mu\text{s}$	
$I_{pul(acq)VIF}$	VIF acquisition pulse current	sink or source	21	-	33	$\mu\text{A}$	
$K_{O(VIF)}$	VIF VCO steepness	$\Delta f_{VIF} / \Delta V_{LFVIF}$	-	26	-	MHz/V	
$K_{D(VIF)}$	VIF phase detector steepness	$\Delta I_{VPLL} / \Delta \phi_{VCO(VIF)}$	-	23	-	$\mu\text{A/rad}$	
$I_{offset(VIF)}$	VIF offset current		-1	0	+1	$\mu\text{A}$	
<b>Video output 2 V; pin CVBS[7]</b>							
Normal mode (sound carrier trap active) and sound carrier on							
$V_{o(video)(p-p)}$	peak-to-peak video output voltage	positive or negative modulation; see <a href="#">Figure 8</a>					
			$W4[7] = 0; W7[4] = 0$	1.7	2.0	2.3	V
			$W4[7] = 1; W7[4] = 0$	1.7	2.0	2.3	V
			$W4[7] = 0; W7[4] = 1$	1.7	2.0	2.3	V
		$W4[7] = 1; W7[4] = 1$	-	2.0	-	V	
$\Delta V_{o(CVBS)}$	CVBS output voltage difference	difference between L and B/G standard					
			$W4[7] = 0; W7[4] = 0$	-240	-	+240	mV
			$W4[7] = 1; W7[4] = 0$	-240	-	+240	mV
			$W4[7] = 0; W7[4] = 1$	-240	-	+240	mV
$V_{video}/V_{sync}$	video voltage to sync voltage ratio		2.0	2.33	2.75		
$V_{syncI}$	sync level voltage	$W4[7] = 0; W7[4] = 0$	1.0	1.2	1.4	V	
		$W4[7] = 1; W7[4] = 0$	0.9	1.2	1.5	V	
		$W4[7] = 0; W7[4] = 1$	0.9	1.2	1.5	V	
$V_{clip(video)u}$	upper video clipping voltage		$V_P - 1.2$	$V_P - 1$	-	V	
$V_{clip(video)l}$	lower video clipping voltage		-	0.4	0.9	V	
$R_O$	output resistance		[3]	-	30	$\Omega$	
$I_{bias(int)}$	internal bias current (DC)	for emitter-follower	1.5	2.0	-	mA	
$I_{sink(o)(max)}$	maximum output sink current	AC and DC	1	-	-	mA	
$I_{source(o)(max)}$	maximum output source current	AC and DC	3.9	-	-	mA	
$\Delta V_{o(CVBS)}$	CVBS output voltage difference	50 dB gain control	-	-	0.5	dB	
		30 dB gain control	-	-	0.1	dB	
$\Delta V_{blt}/V_{CVBS}$	black level tilt to CVBS voltage ratio	negative modulation	-	-	1	%	

**Table 55. Characteristics ...continued**

$V_P = 5\text{ V}$ ;  $T_{amb} = 25\text{ °C}$ ; see [Table 26](#) for input frequencies; B/G standard is used for the specification ( $f_{PC} = 38.375\text{ MHz}$ ;  $f_{SC} = 32.875\text{ MHz}$ ;  $PC / SC = 13\text{ dB}$ ;  $f_{AF} = 400\text{ Hz}$ ); input level  $V_{i(IF)} = 10\text{ mV (RMS)}$  (sync level for B/G; peak white level for L); IF input from  $50\text{ }\Omega$  via broadband transformer 1 : 1; video modulation: Vestigial SideBand (VSB); residual carrier for B/G is 10 % and for L is 3 %; video signal in accordance with "ITU-T J.63 line 17 and line 330" or "NTC-7 Composite"; internal Nyquist slope switched on ( $W7[0] = 0$ ); not dual mode; measurements taken in test circuit of [Figure 49](#); unless otherwise specified.

Symbol	Parameter	Conditions	Min	Typ	Max	Unit
$\Delta V_{\text{blt}(v)}/V_{\text{CVBS}}$	vertical black level tilt to CVBS voltage ratio	worst case in L standard; vision carrier modulated by test line [Vertical Interval Test Signal (VITS)] only	-	-	3	%
$G_{\text{dif}}$	differential gain	"ITU-T J.63 line 330"	[8]			
		B/G standard	-	-	5	%
		L standard	-	-	7	%
$\varphi_{\text{dif}}$	differential phase	"ITU-T J.63 line 330"	[8]			
		B/G standard	-	2	4	deg
		L standard	-	2	4	deg
$(S/N)_w$	weighted signal-to-noise ratio	B/G standard; 50 % grey video signal; unified weighting filter ("ITU-T J.61"); see <a href="#">Figure 19</a>	[9] 53	57	-	dB
$(S/N)_{\text{unw}}$	unweighted signal-to-noise ratio	M/N standard; 50 IRE grey video signal; see <a href="#">Figure 19</a>	47	51	-	dB
$V_{\text{PC}(\text{rsd})(\text{RMS})}$	RMS residual picture carrier voltage	fundamental wave and harmonics	-	2	5	mV
$\Delta f_{\text{PC}(p-p)}$	peak-to-peak picture carrier frequency variation	3 % residual carrier; 50 % serration pulses; L standard	[3] -	-	12	kHz
$\Delta\varphi$	phase difference	0 % residual carrier; 50 % serration pulses; L standard; L-gating = 0 %	[3] -	-	3	%
$\alpha_{\text{H}(\text{video})}$	video harmonics suppression	AC load: $C_L < 20\text{ pF}$ , $R_L > 1\text{ k}\Omega$	[10] 35	40	-	dB
$\alpha_{\text{sp}}$	spurious suppression		[11] 40	-	-	dB
$\text{PSRR}_{\text{CVBS}}$	power supply ripple rejection on pin CVBS	$f_{\text{ripple}} = 70\text{ Hz}$ ; video signal; grey level; positive and negative modulation; see <a href="#">Figure 9</a>	14	20	-	dB
<b>M/N standard inclusive Korea; see <a href="#">Figure 20</a>[12]</b>						
$\alpha_{\text{ripple}(\text{resp})f}$	frequency response ripple	0.5 MHz to 2.5 MHz	-1	-	+1	dB
		2.5 MHz to 3.6 MHz	-2	-	+2	dB
		3.6 MHz to 3.8 MHz	-3	-	+2	dB
		3.8 MHz to 4.2 MHz	-16	-	+2	dB
$\alpha_{\text{SC1}}$	first sound carrier attenuation	$f = f_{\text{SC1}} = 4.5\text{ MHz}$	38	-	-	dB
		$f = f_{\text{SC1}} \pm 60\text{ kHz}$	29	-	-	dB

**Table 55. Characteristics ...continued**

$V_P = 5\text{ V}$ ;  $T_{amb} = 25\text{ °C}$ ; see [Table 26](#) for input frequencies; B/G standard is used for the specification ( $f_{PC} = 38.375\text{ MHz}$ ;  $f_{SC} = 32.875\text{ MHz}$ ;  $PC / SC = 13\text{ dB}$ ;  $f_{AF} = 400\text{ Hz}$ ); input level  $V_{i(IF)} = 10\text{ mV (RMS)}$  (sync level for B/G; peak white level for L); IF input from  $50\text{ }\Omega$  via broadband transformer 1 : 1; video modulation: Vestigial SideBand (VSB); residual carrier for B/G is 10 % and for L is 3 %; video signal in accordance with "ITU-T J.63 line 17 and line 330" or "NTC-7 Composite"; internal Nyquist slope switched on ( $W7[0] = 0$ ); not dual mode; measurements taken in test circuit of [Figure 49](#); unless otherwise specified.

Symbol	Parameter	Conditions	Min	Typ	Max	Unit
$\alpha_{SC2}$	second sound carrier attenuation	$f = f_{SC2} = 4.724\text{ MHz}$	25	-	-	dB
		$f = f_{SC2} \pm 60\text{ kHz}$	16	-	-	dB
$t_{d(grp)CC}$	color carrier group delay time	$f = 3.58\text{ MHz}$ ; including transmitter pre-correction; see <a href="#">Figure 21</a>	[13] -75	-50	+75	ns

B/G standard; see [Figure 22\[12\]](#)

$\alpha_{ripple(resp)f}$	frequency response ripple	0.5 MHz to 3.2 MHz	-1	-	+1	dB
		3.2 MHz to 4.5 MHz	-2	-	+2	dB
		4.5 MHz to 4.8 MHz	-4	-	+2	dB
		4.8 MHz to 5 MHz	-12	-	+2	dB
$\alpha_{SC1}$	first sound carrier attenuation	$f = f_{SC1} = 5.5\text{ MHz}$	35	-	-	dB
		$f = f_{SC1} \pm 60\text{ kHz}$	26	-	-	dB
$\alpha_{SC2}$	second sound carrier attenuation	$f = f_{SC2} = 5.742\text{ MHz}$	25	-	-	dB
		$f = f_{SC2} \pm 60\text{ kHz}$	16	-	-	dB
$\alpha_{SC(NICAM)}$	NICAM sound carrier attenuation	$f_{car(NICAM)} = 5.85\text{ MHz}$ ; $f = f_{car(NICAM)} \pm 250\text{ kHz}$	12	-	-	dB
$\alpha$	attenuation	$f = f_{(N+1)ch} = 7\text{ MHz}$	21	-	-	dB
		$f = f_{(N+1)ch} \pm 750\text{ kHz}$	5	-	-	dB
$t_{d(grp)CC}$	color carrier group delay time	$f = 4.43\text{ MHz}$ ; including transmitter pre-correction; see <a href="#">Figure 23</a>	[13] -75	-10	+75	ns

I standard; see [Figure 24\[12\]](#)

$\alpha_{ripple(resp)f}$	frequency response ripple	0.5 MHz to 3.2 MHz	-1	-	+1	dB
		3.2 MHz to 4.5 MHz	-2	-	+2	dB
		4.5 MHz to 5 MHz	-4	-	+2	dB
		5 MHz to 5.5 MHz	-12	-	+2	dB
$\alpha_{SC1}$	first sound carrier attenuation	$f = f_{SC1} = 6.0\text{ MHz}$	35	-	-	dB
		$f = f_{SC1} \pm 60\text{ kHz}$	26	-	-	dB
$\alpha_{SC(NICAM)}$	NICAM sound carrier attenuation	$f_{car(NICAM)} = 6.55\text{ MHz}$ ; $f = f_{car(NICAM)} \pm 250\text{ kHz}$	12	-	-	dB
$t_{d(grp)CC}$	color carrier group delay time	$f = 4.43\text{ MHz}$ ; see <a href="#">Figure 25</a>	[13] -75	-15	+75	ns

D/K standard; see [Figure 26\[12\]](#)

$\alpha_{ripple(resp)f}$	frequency response ripple	0.5 MHz to 3.1 MHz	-1	-	+1	dB
		3.1 MHz to 4.5 MHz	-2	-	+2	dB
		4.5 MHz to 4.8 MHz	-4	-	+2	dB
		4.8 MHz to 5.1 MHz	-6	-	+2	dB



**Table 55. Characteristics ...continued**

$V_P = 5\text{ V}$ ;  $T_{amb} = 25\text{ }^\circ\text{C}$ ; see [Table 26](#) for input frequencies; B/G standard is used for the specification ( $f_{PC} = 38.375\text{ MHz}$ ;  $f_{SC} = 32.875\text{ MHz}$ ;  $PC / SC = 13\text{ dB}$ ;  $f_{AF} = 400\text{ Hz}$ ); input level  $V_{i(IF)} = 10\text{ mV (RMS)}$  (sync level for B/G; peak white level for L); IF input from  $50\text{ }\Omega$  via broadband transformer 1 : 1; video modulation: Vestigial SideBand (VSB); residual carrier for B/G is 10 % and for L is 3 %; video signal in accordance with "ITU-T J.63 line 17 and line 330" or "NTC-7 Composite"; internal Nyquist slope switched on ( $W7[0] = 0$ ); not dual mode; measurements taken in test circuit of [Figure 49](#); unless otherwise specified.

Symbol	Parameter	Conditions	Min	Typ	Max	Unit
$\alpha_{SC1}$	first sound carrier attenuation	$f = f_{SC1} = 6.5\text{ MHz}$	35	-	-	dB
		$f = f_{SC1} \pm 60\text{ kHz}$	26	-	-	dB
$\alpha_{SC2(us)}$	second sound carrier attenuation (upper side)	$f = f_{SC2} = 6.742\text{ MHz}$	25	-	-	dB
		$f = f_{SC2} \pm 60\text{ kHz}$	16	-	-	dB
$\alpha_{SC2(ls)}$	second sound carrier attenuation (lower side)	$f = f_{SC2} = 6.258\text{ MHz}$	25	-	-	dB
		$f = f_{SC2} \pm 60\text{ kHz}$	16	-	-	dB
$\alpha_{SC(NICAM)}$	NICAM sound carrier attenuation	$f_{car(NICAM)} = 5.85\text{ MHz}$ ; $f = f_{car(NICAM)} \pm 250\text{ kHz}$	6	-	-	dB
$t_{d(grp)CC}$	color carrier group delay time	$f = 4.28\text{ MHz}$ ; including transmitter pre-correction; see <a href="#">Figure 27</a>	[13] -50	0	+100	ns

L standard; see [Figure 28](#)[12]

$\alpha_{ripple(resp)f}$	frequency response ripple	0.5 MHz to 3.2 MHz	-1	-	+1	dB
		3.2 MHz to 4.5 MHz	-2	-	+2	dB
		4.5 MHz to 4.8 MHz	-4	-	+2	dB
		4.8 MHz to 5.3 MHz	-12	-	+2	dB
$\alpha_{SC(NICAM)}$	NICAM sound carrier attenuation	$f_{car(NICAM)} = 5.85\text{ MHz}$ ; $f = f_{car(NICAM)} \pm 250\text{ kHz}$	5	-	-	dB
$\alpha_{SC(AM)}$	AM sound carrier attenuation	$f = f_{SC(AM)} = 6.5\text{ MHz}$	38	-	-	dB
		$f = f_{SC(AM)} \pm 30\text{ kHz}$	29	-	-	dB
$t_{d(grp)CC}$	color carrier group delay time	$f = 4.28\text{ MHz}$ ; including transmitter pre-correction; see <a href="#">Figure 29</a>	-75	-5	+75	ns

**Video output 1.1 V; pin CVBS**

Trap bypass mode and sound carrier off[12]

$V_{o(video)(p-p)}$	peak-to-peak video output voltage	see <a href="#">Figure 8</a>	-	1.1	-	V
$V_{syncl}$	sync level voltage		-	1.5	-	V
$V_{clip(video)u}$	upper video clipping voltage		$V_P - 1.1$	$V_P - 1$	-	V
$V_{clip(video)l}$	lower video clipping voltage		-	0.4	0.9	V
$B_{video(-3dB)}$	-3 dB video bandwidth	AC load: $C_L < 20\text{ pF}$ , $R_L > 1\text{ k}\Omega$	6	8	-	MHz
$(S/N)_w$	weighted signal-to-noise ratio	B/G standard; 50 % grey video signal; unified weighting filter ("ITU-T J.61"); see <a href="#">Figure 19</a>	[9] 54	-	-	dB
$(S/N)_{unw}$	unweighted signal-to-noise ratio	M/N standard; 50 IRE grey video signal; see <a href="#">Figure 19</a>	[9] 47	51	-	dB

**Table 55. Characteristics ...continued**

$V_P = 5\text{ V}$ ;  $T_{amb} = 25\text{ °C}$ ; see [Table 26](#) for input frequencies; B/G standard is used for the specification ( $f_{PC} = 38.375\text{ MHz}$ ;  $f_{SC} = 32.875\text{ MHz}$ ;  $PC / SC = 13\text{ dB}$ ;  $f_{AF} = 400\text{ Hz}$ ); input level  $V_{i(IF)} = 10\text{ mV (RMS)}$  (sync level for B/G; peak white level for L); IF input from  $50\text{ }\Omega$  via broadband transformer 1 : 1; video modulation: Vestigial SideBand (VSB); residual carrier for B/G is 10 % and for L is 3 %; video signal in accordance with "ITU-T J.63 line 17 and line 330" or "NTC-7 Composite"; internal Nyquist slope switched on ( $W7[0] = 0$ ); not dual mode; measurements taken in test circuit of [Figure 49](#); unless otherwise specified.

Symbol	Parameter	Conditions	Min	Typ	Max	Unit
<b>Loop filter synthesizer; pin LFSYN1</b>						
$V_{LFSYN1}$	voltage on pin LFSYN1		1.0	-	3.5	V
$I_{source(o)PD(max)}$	maximum phase detector output source current		-	-	65	$\mu\text{A}$
$I_{sink(o)PD(max)}$	maximum phase detector output sink current		-	-	65	$\mu\text{A}$
$K_O$	VCO steepness		-	3.75	-	MHz/V
$K_D$	phase detector steepness		-	9	-	$\mu\text{A/rad}$
<b>Pin MPP1 operating as VIF AGC voltage monitor</b>						
$V_{monitor(VIFAGC)}$	VIF AGC monitor voltage		[3] 0.5	-	4.5	V
$V_{AGC}$	AGC voltage	see <a href="#">Figure 10</a> ; $V_{i(IF)}$ set to				
		1 mV (60 dB $\mu\text{V}$ )	2.2	-	2.6	V
		10 mV (80 dB $\mu\text{V}$ )	2.5	-	3.1	V
		200 mV (106 dB $\mu\text{V}$ )	3	-	4	V
$I_{o(max)}$	maximum output current	sink or source	10	-	-	$\mu\text{A}$
$t_{resp}$	response time	increasing VIF step; negative modulation	[14]			
		normal mode	-	4.3	-	$\mu\text{s/dB}$
		fast mode	-	1.5	-	$\mu\text{s/dB}$
		increasing VIF step; positive modulation; normal mode	[14]	-	130	$\mu\text{s/dB}$
		decreasing VIF step; negative modulation	[14]			
		normal mode	-	1.9	-	ms/dB
		fast normal mode	-	0.08	-	ms/dB
		2nd mode	-	0.25	-	ms/dB
		fast 2nd mode	-	0.01	-	ms/dB
		decreasing VIF step; positive modulation	[14]			
		20 dB	-	890	-	ms
		fast mode	-	2.6	-	ms/dB
		normal mode	-	143	-	ms/dB
$\alpha_{th(fast)VIF}$	VIF fast mode threshold	L standard	-10	-6	-2	dB
$\Delta V_{VAGC(step)}$	VIF AGC voltage difference (step)	see <a href="#">Table 11</a>	-	40	-	mV/bit
<b>Pin MPP1 operating as open-collector output port</b>						
$V_{OL}$	LOW-level output voltage	$I = 2\text{ mA (sink)}$	-	-	0.4	V

**Table 55. Characteristics ...continued**

$V_P = 5\text{ V}$ ;  $T_{amb} = 25\text{ }^\circ\text{C}$ ; see [Table 26](#) for input frequencies; B/G standard is used for the specification ( $f_{PC} = 38.375\text{ MHz}$ ;  $f_{SC} = 32.875\text{ MHz}$ ;  $PC / SC = 13\text{ dB}$ ;  $f_{AF} = 400\text{ Hz}$ ); input level  $V_{i(IF)} = 10\text{ mV (RMS)}$  (sync level for B/G; peak white level for L); IF input from  $50\text{ }\Omega$  via broadband transformer 1 : 1; video modulation: Vestigial SideBand (VSB); residual carrier for B/G is 10 % and for L is 3 %; video signal in accordance with "ITU-T J.63 line 17 and line 330" or "NTC-7 Composite"; internal Nyquist slope switched on ( $W7[0] = 0$ ); not dual mode; measurements taken in test circuit of [Figure 49](#); unless otherwise specified.

Symbol	Parameter	Conditions	Min	Typ	Max	Unit
$I_{\text{sink(o)}}$	output sink current	$W7[3] = 0$	-	-	3	mA
		$W7[3] = 1$	-	-	10	$\mu\text{A}$
$V_{\text{OH}}$	HIGH-level output voltage		-	-	$V_P + 0.5$	V

**VIF AGC; pin CIFAGC**

$I_{\text{ch(max)}}$	maximum charge current	L standard	75	100	125	$\mu\text{A}$
$I_{\text{ch(add)}}$	additional charge current	L standard: in the event of missing VITS pulses and no white video content	-	100	-	nA
$I_{\text{dch}}$	discharge current	L standard; normal mode	-	35	-	nA
		L standard; fast mode	-	1.8	-	$\mu\text{A}$

**VIF AGC control; pin AGCVIN**

$I_{\text{sink(i)(max)}}$	maximum input sink current		[3] -	-	1	$\mu\text{A}$
$I_{\text{source(i)(max)}}$	maximum input source current		[3] -	-	1	$\mu\text{A}$
$V_{\text{i(max)}}$	maximum input voltage		[3] -	-	$V_P$	V
$V_{\text{AGCVIN}}$	voltage on pin AGCVIN		[3] 1	-	3.5	V
$\Delta G_{\text{VIF}}/\Delta V_{\text{AGCVIN}}$	change of VIF gain with voltage on pin AGCVIN	$V_{\text{AGCVIN}} = 2.8\text{ V}$	-	-75	-	dB/V

**Tuner AGC; pin TAGC**

Integral TAGC loop mode ( $W6[7:6] = 10$ ); TAGC is current output; applicable for negative modulation only; unmodulated VIF; see [Table 48](#) and [Figure 12](#)

$V_{\text{i(IF)(RMS)}}$	RMS IF input voltage	at starting point of tuner AGC takeover; $I_{\text{sink(TAGC)}} = 100\text{ }\mu\text{A}$					
			$W9[4:0] = 0\text{ }0000$	-	57.9	-	dB $\mu\text{V}$
			$W9[4:0] = 1\text{ }0000$	-	78.7	-	dB $\mu\text{V}$
			$W9[4:0] = 1\text{ }1111$	-	98.2	-	dB $\mu\text{V}$
$\alpha_{\text{acc(set)TOP}}$	TOP setting accuracy		-2	-	+2	dB	
$I_{\text{source}}$	source current	TAGC charge current					
		normal mode	0.20	0.27	0.34	$\mu\text{A}$	
		fast mode activated by internal level detector	7	10	13	$\mu\text{A}$	
$I_{\text{sink}}$	sink current	TAGC discharge current; $V_{\text{TAGC}} = 1\text{ V}$	400	500	600	$\mu\text{A}$	
$\Delta\alpha_{\text{acc(set)TOP}}/\Delta T$	TOP setting accuracy variation with temperature	$W9[4:0] = 1\text{ }0000$	-	-	0.02	dB/K	
$R_L$	load resistance		[3] 50	-	-	M $\Omega$	
$V_{\text{sat(u)}}$	upper saturation voltage	pin operating as current output	$V_P - 0.3$	-	-	V	

**Table 55. Characteristics ...continued**

$V_P = 5\text{ V}$ ;  $T_{amb} = 25\text{ }^\circ\text{C}$ ; see [Table 26](#) for input frequencies; B/G standard is used for the specification ( $f_{PC} = 38.375\text{ MHz}$ ;  $f_{SC} = 32.875\text{ MHz}$ ;  $PC / SC = 13\text{ dB}$ ;  $f_{AF} = 400\text{ Hz}$ ); input level  $V_{i(IF)} = 10\text{ mV (RMS)}$  (sync level for B/G; peak white level for L); IF input from  $50\text{ }\Omega$  via broadband transformer 1 : 1; video modulation: Vestigial SideBand (VSB); residual carrier for B/G is 10 % and for L is 3 %; video signal in accordance with "ITU-T J.63 line 17 and line 330" or "NTC-7 Composite"; internal Nyquist slope switched on ( $W7[0] = 0$ ); not dual mode; measurements taken in test circuit of [Figure 49](#); unless otherwise specified.

Symbol	Parameter	Conditions	Min	Typ	Max	Unit
$V_{sat(l)}$	lower saturation voltage	pin operating as current output	-	-	0.3	V
$\alpha_{th(fast)AGC}$	AGC fast mode threshold	activated by internal fast AGC detector; I <sup>2</sup> C-bus setting corresponds to $W9[4:0] = 1\ 0000$	<a href="#">[3]</a> 6	8	10	dB
$t_d$	delay time	before activating; $V_{i(IF)}$ below $\alpha_{th(fast)AGC}$	40	60	80	ms
TAGC loop based on VIF AGC ( $W6[7:6] = 11$ ); TAGC is voltage output; applicable for TV mode: positive modulation and optional for negative modulation); see <a href="#">Table 51</a> ; <a href="#">Figure 12</a> and <a href="#">Figure 13</a>						
$V_{i(IF)(RMS)}$	RMS IF input voltage	at starting point of tuner AGC takeover; $V_{TAGC} = 3.5\text{ V}$				
		$R_{TOP2} = 22\text{ k}\Omega$ or $W10[5:0] = 00\ 0000$	-	61	-	dB $\mu$ V
		$R_{TOP2} = 10\text{ k}\Omega$ or $W10[5:0] = 01\ 0000$	-	81	-	dB $\mu$ V
		$R_{TOP2} = 0\text{ k}\Omega$ $W10[5:0] = 01\ 1111$	-	96 99	-	dB $\mu$ V dB $\mu$ V
$\alpha_{acc(set)TOP2}$	TOP2 setting accuracy		-6	-	+6	dB
$\Delta\alpha_{acc(set)TOP2}/\Delta T$	TOP2 setting accuracy variation with temperature	$V_{TAGC} = 3.5\text{ V}$	-	0.03	0.07	dB/K
$V_O$	output voltage	no tuner gain reduction	4.5	-	$V_P$	V
		maximum tuner gain reduction	0.2	-	0.6	V
$\Delta G_{slip(TAGC)}$	TAGC slip gain offset	tuner gain voltage from 0.6 V to 3.5 V	3	5	8	dB
<b>TOP adjust 2; pin TOP2; IF based TAGC loop mode; see <a href="#">Figure 13</a></b>						
$V_{TOP2}$	voltage on pin TOP2 (DC)	pin open-circuit	-	3.5	-	V
$R_I$	input resistance		-	27	-	k $\Omega$
$R_{TOP2}$	resistance on pin TOP2	adjustment of VIF AGC based TAGC loop				
		$W10[5] = 1$ ; external resistor operation	0	-	22	k $\Omega$
		$W10[5] = 0$ ; forced I <sup>2</sup> C-bus operation	100	-	-	k $\Omega$

**Table 55. Characteristics ...continued**

$V_P = 5\text{ V}$ ;  $T_{amb} = 25\text{ }^\circ\text{C}$ ; see [Table 26](#) for input frequencies; B/G standard is used for the specification ( $f_{PC} = 38.375\text{ MHz}$ ;  $f_{SC} = 32.875\text{ MHz}$ ;  $PC / SC = 13\text{ dB}$ ;  $f_{AF} = 400\text{ Hz}$ ); input level  $V_{i(IF)} = 10\text{ mV (RMS)}$  (sync level for B/G; peak white level for L); IF input from  $50\text{ }\Omega$  via broadband transformer 1 : 1; video modulation: Vestigial SideBand (VSB); residual carrier for B/G is 10 % and for L is 3 %; video signal in accordance with "ITU-T J.63 line 17 and line 330" or "NTC-7 Composite"; internal Nyquist slope switched on ( $W7[0] = 0$ ); not dual mode; measurements taken in test circuit of [Figure 49](#); unless otherwise specified.

Symbol	Parameter	Conditions	Min	Typ	Max	Unit
<b>AGC switch; pin AGCSWI</b>						
$V_{AGCSWI}$	voltage on pin AGCSWI (DC)	pin open-circuit	-	0	-	V
		LOW-level input voltage; see <a href="#">Table 34</a>	-	-	1	V
		HIGH-level input voltage; see <a href="#">Table 34</a>	2	-	-	V
$R_i$	input resistance		-	50	-	k $\Omega$
<b>Pin CTAGC</b>						
$V_{CTAGC}$	voltage on pin CTAGC		[3] 0.2	-	0.55V <sub>P</sub>	V
$I_L$	leakage current	sink	[3] -	-	10	nA
		source	[3] -	-	10	nA
<b>Control current or voltage monitor output; pin MPP2</b>						
<b>General</b>						
$V_{sat(u)}$	upper saturation voltage		$V_P - 0.8$	$V_P - 0.5$	-	V
$V_{sat(l)}$	lower saturation voltage		-	0.5	0.8	V
<b>AFC (current output)</b>						
$I_o$	output current	sink or source; see <a href="#">Figure 16</a> and <a href="#">Figure 17</a>	[15][16]			
		100 kHz VIF deviation	80	-	160	$\mu\text{A}$
		200 kHz VIF deviation	160	200	240	$\mu\text{A}$
		1.5 MHz VIF deviation	160	-	240	$\mu\text{A}$
<b>AFC TV mode</b>						
$\Delta I_{AFC} / \Delta f_{VIF}$	change of AFC current with VIF frequency		[16] 0.85	1.05	1.25	$\mu\text{A/kHz}$
$f_{VIFacc(dig)}$	digital accuracy of VIF frequency	read-out via I <sup>2</sup> C-bus; R1[4:1] = $f_0$ ; $f_{ref} = 4\text{ MHz}$	[17] -20	-	+20	kHz
$f_{VIFacc(a)}$	analog accuracy of VIF frequency	$I_{AFC} = 0\text{ A}$ ; $f_{ref} = 4\text{ MHz}$	[17] -20	-	+20	kHz
<b>AFC radio mode</b>						
$\Delta I_{AFC} / \Delta f_{RIF}$	change of AFC current with RIF frequency		[16] 0.85	1.05	1.25	$\mu\text{A/kHz}$
$f_{RIFacc(dig)}$	digital accuracy of RIF frequency	read-out via I <sup>2</sup> C-bus; R1[4:1] = $f_0$ ; $f_{ref} = 4\text{ MHz}$	[17] -10	-	+10	kHz
$f_{RIFacc(a)}$	analog accuracy of RIF frequency	$I_{AFC} = 0\text{ A}$ ; $f_{ref} = 4\text{ MHz}$	[17] -10	-	+10	kHz

**Table 55. Characteristics ...continued**

$V_P = 5\text{ V}$ ;  $T_{amb} = 25\text{ °C}$ ; see [Table 26](#) for input frequencies; B/G standard is used for the specification ( $f_{PC} = 38.375\text{ MHz}$ ;  $f_{SC} = 32.875\text{ MHz}$ ;  $PC / SC = 13\text{ dB}$ ;  $f_{AF} = 400\text{ Hz}$ ); input level  $V_{i(IF)} = 10\text{ mV (RMS)}$  (sync level for B/G; peak white level for L); IF input from  $50\ \Omega$  via broadband transformer 1 : 1; video modulation: Vestigial SideBand (VSB); residual carrier for B/G is 10 % and for L is 3 %; video signal in accordance with "ITU-T J.63 line 17 and line 330" or "NTC-7 Composite"; internal Nyquist slope switched on ( $W7[0] = 0$ ); not dual mode; measurements taken in test circuit of [Figure 49](#); unless otherwise specified.

Symbol	Parameter	Conditions	Min	Typ	Max	Unit
<b>AGC or WAFP monitor (voltage output)</b>						
$G_v$	voltage gain	voltage on pin MPP2 to internal control voltage; see <a href="#">Table 33</a>	-	0	-	dB
		SIF AGC	-	6	-	dB
		FM AGC	-	6	-	dB
		WAFP	-	6	-	dB
		TAGC	-	0	-	dB
$I_{o(max)}$	maximum output current	sink or source	350	-	-	$\mu\text{A}$
<b>SIF amplifier; pins IF3A and IF3B or pins IF1A and IF1B or pins IF2A and IF2B</b>						
$V_i$	input voltage		-	1.95	-	V
$R_{i(dif)}$	differential input resistance		-	2	-	$\text{k}\Omega$
$C_{i(dif)}$	differential input capacitance		-	3	-	pF
$V_{i(SIF)(RMS)}$	RMS SIF input voltage	FM mode; -3 dB at intercarrier output pins OUT1A and OUT1B; without FM AGC; see <a href="#">Table 22</a>	-	60	100	$\mu\text{V}$
		AM mode; -3 dB at AF output pin AUD	-	40	70	$\mu\text{V}$
		FM mode; +1 dB at intercarrier output pins OUT1A and OUT1B; without FM AGC; see <a href="#">Table 22</a>	150	190	-	mV
		AM mode; +1 dB at AF output pin AUD	70	140	-	mV
		permissible overload	-	-	320	mV
$G_{SIF(cr)}$	control range SIF gain	FM and AM mode	60	66	-	dB
$f_{-3dB(SIF)l}$	lower SIF cut-off frequency		-	7	-	MHz
$f_{-3dB(SIF)u}$	upper SIF cut-off frequency		-	80	-	MHz
<b>Buffered SIF; pins OUT2A and OUT2B</b>						
$V_{o(dif)(p-p)}$	peak-to-peak differential output voltage	$W6[0] = 1$ ; $W4[7] = 0$ ; $f_{SIF} \leq 45\text{ MHz}$				
		$W2[7] = 1$	-	1.0	-	V
		$W2[7] = 0$ ; AM = 0 %	-	0.5	-	V
		$W6[0] = 1$ ; $W4[7] = 1$ ; $f_{SIF} \leq 60\text{ MHz}$				
		$W2[7] = 1$	-	0.5	-	V
	$W2[7] = 0$ ; AM = 0 %	-	0.25	-	V	

**Table 55. Characteristics ...continued**

$V_P = 5\text{ V}$ ;  $T_{amb} = 25\text{ }^\circ\text{C}$ ; see [Table 26](#) for input frequencies; B/G standard is used for the specification ( $f_{PC} = 38.375\text{ MHz}$ ;  $f_{SC} = 32.875\text{ MHz}$ ;  $PC / SC = 13\text{ dB}$ ;  $f_{AF} = 400\text{ Hz}$ ); input level  $V_{i(IF)} = 10\text{ mV (RMS)}$  (sync level for B/G; peak white level for L); IF input from  $50\text{ }\Omega$  via broadband transformer 1 : 1; video modulation: Vestigial SideBand (VSB); residual carrier for B/G is 10 % and for L is 3 %; video signal in accordance with "ITU-T J.63 line 17 and line 330" or "NTC-7 Composite"; internal Nyquist slope switched on ( $W7[0] = 0$ ); not dual mode; measurements taken in test circuit of [Figure 49](#); unless otherwise specified.

Symbol	Parameter	Conditions	Min	Typ	Max	Unit
$R_{L(max)}$	maximum load resistance	single-ended to GND	1	-	-	k $\Omega$
$C_{L(max)}$	maximum load capacitance	single-ended to GND	-	-	5	pF

**SIF AGC detector; pin MPP2; see [Figure 15](#)**

$t_{resp}$	response time	increasing or decreasing SIF step of 20 dB; AM mode; fast AGC				
		increasing	-	8	-	ms
		decreasing	-	25	-	ms
		increasing or decreasing SIF step of 20 dB; AM mode; slow AGC				
		increasing	-	80	-	ms
		decreasing	-	250	-	ms
		increasing or decreasing SIF step of 20 dB; FM mode; normal AGC				
		increasing	-	0.3	-	ms
		decreasing	-	20	-	ms
		increasing or decreasing SIF step of 20 dB; FM mode; fast AGC				
		increasing	-	0.1	-	ms
		decreasing	-	4	-	ms
$V_{AGC(SIF)}$	SIF AGC voltage	FM mode				
		$V_{SIF} = 100\text{ }\mu\text{V}$	1.5	-	2.4	V
		$V_{SIF} = 10\text{ mV}$	2.6	-	3.4	V
		$V_{SIF} = 140\text{ mV}$	3.3	-	$V_P$	V
		AM mode				
		$V_{SIF} = 100\text{ }\mu\text{V}$	1.5	-	2.4	V
		$V_{SIF} = 10\text{ mV}$	2.9	-	3.9	V
		$V_{SIF} = 140\text{ mV}$	3.3	-	$V_P$	V

**Conversion synthesizer PLL; pin LFSYN2 (TSS mode)**

$V_{LFSYN2}$	voltage on pin LFSYN2		1	-	3	V
$K_O$	VCO steepness	$\Delta f_{VCO} / \Delta V_{LFSYN2}$	-	31	-	MHz/V

**Table 55. Characteristics ...continued**

$V_P = 5\text{ V}$ ;  $T_{amb} = 25\text{ °C}$ ; see [Table 26](#) for input frequencies; B/G standard is used for the specification ( $f_{PC} = 38.375\text{ MHz}$ ;  $f_{SC} = 32.875\text{ MHz}$ ;  $PC / SC = 13\text{ dB}$ ;  $f_{AF} = 400\text{ Hz}$ ); input level  $V_{i(IF)} = 10\text{ mV (RMS)}$  (sync level for B/G; peak white level for L); IF input from  $50\text{ }\Omega$  via broadband transformer 1 : 1; video modulation: Vestigial SideBand (VSB); residual carrier for B/G is 10 % and for L is 3 %; video signal in accordance with "ITU-T J.63 line 17 and line 330" or "NTC-7 Composite"; internal Nyquist slope switched on ( $W7[0] = 0$ ); not dual mode; measurements taken in test circuit of [Figure 49](#); unless otherwise specified.

Symbol	Parameter	Conditions	Min	Typ	Max	Unit
$K_D$	phase detector steepness	$\Delta I_{LFSYN2} / \Delta \phi_{VCO}$ ; see <a href="#">Table 59</a> ; $f_{VCO}$ selection:				
		22 MHz to 29.5 MHz	-	32	-	$\mu\text{A/rad}$
		30 MHz to 37.5 MHz	-	38	-	$\mu\text{A/rad}$
		38 MHz to 45.5 MHz	-	47	-	$\mu\text{A/rad}$
		46 MHz to 53.5 MHz	-	61	-	$\mu\text{A/rad}$
$I_{o(PD)}$	phase detector output current	sink or source; $f_{VCO}$ selection:				
		22 MHz to 29.5 MHz	-	200	-	$\mu\text{A}$
		30 MHz to 37.5 MHz	-	238	-	$\mu\text{A}$
		38 MHz to 45.5 MHz	-	294	-	$\mu\text{A}$
		46 MHz to 53.5 MHz	-	384	-	$\mu\text{A}$
$\Phi_n(\text{synth})$	synthesizer phase noise	with 4 MHz crystal oscillator reference; $f_{\text{synth}} = 31\text{ MHz}$ ; $f_{IF} = 36\text{ MHz}$				
		at 1 kHz	<a href="#">[3]</a> 89	99	-	$\text{dBc/Hz}$
		at 10 kHz	<a href="#">[3]</a> 89	99	-	$\text{dBc/Hz}$
		at 100 kHz	<a href="#">[3]</a> 98	102	-	$\text{dBc/Hz}$
		at 1.4 MHz	<a href="#">[3]</a> 115	119	-	$\text{dBc/Hz}$
$\alpha_{sp}$	spurious suppression	multiple of $\Delta f = 500\text{ kHz}$	<a href="#">[3]</a> 50	-	-	$\text{dBc}$
$I_L$	leakage current	synthesizer spurious performance > 50 dBc	<a href="#">[3]</a> -	-	10	$\text{nA}$
PSRR	power supply ripple rejection	residual spurious at nominal differential output voltage dependent on power supply ripple at 70 Hz; see <a href="#">Figure 9</a>	-	50	-	$\text{dB}$

**Single reference QSS/TSS intercarrier mixer; pins OUT1A and OUT1B**

$V_{OUT1A}$	voltage on pin OUT1A (DC)		1.8	2.0	2.2	V
$V_{OUT1B}$	voltage on pin OUT1B (DC)		1.8	2.0	2.2	V
$I_{bias(int)}$	internal bias current (DC)	for emitter-follower	2.0	2.5	-	$\text{mA}$
$I_{sink(o)(max)}$	maximum output sink current	DC and AC	1.4	1.7	-	$\text{mA}$
$I_{source(o)(max)}$	maximum output source current	DC and AC; with external resistor to GND	3.0	-	-	$\text{mA}$



**Table 55. Characteristics ...continued**

$V_P = 5\text{ V}$ ;  $T_{amb} = 25\text{ }^\circ\text{C}$ ; see [Table 26](#) for input frequencies; B/G standard is used for the specification ( $f_{PC} = 38.375\text{ MHz}$ ;  $f_{SC} = 32.875\text{ MHz}$ ;  $PC / SC = 13\text{ dB}$ ;  $f_{AF} = 400\text{ Hz}$ ); input level  $V_{i(IF)} = 10\text{ mV (RMS)}$  (sync level for B/G; peak white level for L); IF input from  $50\text{ }\Omega$  via broadband transformer 1 : 1; video modulation: Vestigial SideBand (VSB); residual carrier for B/G is 10 % and for L is 3 %; video signal in accordance with "ITU-T J.63 line 17 and line 330" or "NTC-7 Composite"; internal Nyquist slope switched on ( $W7[0] = 0$ ); not dual mode; measurements taken in test circuit of [Figure 49](#); unless otherwise specified.

Symbol	Parameter	Conditions	Min	Typ	Max	Unit
$R_O$	output resistance	output active; single-ended to GND	-	-	25	$\Omega$
		output inactive; internal resistance to GND	-	800	-	$\Omega$
$V_{o(RMS)}$	RMS output voltage	IF intercarrier single-ended to GND; SC1 on; SC2 off	90	140	180	mV
		IF intercarrier single-ended to GND; L standard; without modulation; BP on				
		$W7[5] = 0$	45	70	90	mV
		$W7[5] = 1$	20	35	45	mV
$f_{-3dB(ic)u}$	upper intercarrier cut-off frequency	internal sound band-pass off	11	15	-	MHz
$\alpha_{image}$	image rejection	band-pass off; -8 MHz to 0 MHz	24	28	-	dB
$V_{interf(RMS)}$	RMS interference voltage	fundamental wave and harmonics	-	2	5	mV

**AM intercarrier from pin EXTFIL to pins OUT1A and OUT1B**

G	gain	IF intercarrier; L standard; without modulation	-	5	-	dB
---	------	--	---	---	---	----

**Table 55. Characteristics ...continued**

$V_P = 5\text{ V}$ ;  $T_{amb} = 25\text{ }^\circ\text{C}$ ; see [Table 26](#) for input frequencies; B/G standard is used for the specification ( $f_{PC} = 38.375\text{ MHz}$ ;  $f_{SC} = 32.875\text{ MHz}$ ;  $PC / SC = 13\text{ dB}$ ;  $f_{AF} = 400\text{ Hz}$ ); input level  $V_{i(IF)} = 10\text{ mV (RMS)}$  (sync level for B/G; peak white level for L); IF input from  $50\text{ }\Omega$  via broadband transformer 1 : 1; video modulation: Vestigial SideBand (VSB); residual carrier for B/G is 10 % and for L is 3 %; video signal in accordance with "ITU-T J.63 line 17 and line 330" or "NTC-7 Composite"; internal Nyquist slope switched on ( $W7[0] = 0$ ); not dual mode; measurements taken in test circuit of [Figure 49](#); unless otherwise specified.

Symbol	Parameter	Conditions	Min	Typ	Max	Unit
<b>Band-pass mode</b>						
$f_c$	center frequency	QSS mode; BP selection for standard				
		M/N	-	4.7	-	MHz
		B/G	-	5.75	-	MHz
		I	-	6.25	-	MHz
		D/K	-	6.25	-	MHz
		L/L-accent	-	6.05	-	MHz
		TSS mode; BP selection recommended for standard				
		M/N, B/G or I	-	5.1	-	MHz
		D/K	-	5.75	-	MHz
		L/L-accent	-	6.95	-	MHz
		radio mode; BP selection for standard				
		M/N	-	4.7	-	MHz
		B/G	-	5.75	-	MHz
		I	-	6.25	-	MHz
		D/K	-	6.78	-	MHz
RADIO	-	10.7	-	MHz		
$f_{-3dB(BP)u}$	upper BP cut-off frequency	M/N, B/G, I, D/K or L/L-accent standard	$f_c + 0.5$	$f_c + 0.65$	$f_c + 0.8$	MHz
		RADIO 10.7	$f_c + 0.25$	$f_c + 0.4$	$f_c + 0.55$	MHz
$f_{-3dB(BP)l}$	lower BP cut-off frequency	M/N, B/G, I, D/K or L/L-accent standard	$f_c - 0.5$	$f_c - 0.65$	$f_c - 0.8$	MHz
		RADIO 10.7	$f_c - 0.25$	$f_c - 0.4$	$f_c - 0.55$	MHz
$\alpha_{stpb}$	stop-band attenuation	at $f_c \pm 1.5\text{ MHz}$				
		M/N, B/G, I, D/K or L/L-accent standard	20	30	-	dB
		RADIO 10.7	15	25	-	dB

**Table 55. Characteristics ...continued**

$V_P = 5\text{ V}$ ;  $T_{amb} = 25\text{ }^\circ\text{C}$ ; see [Table 26](#) for input frequencies; B/G standard is used for the specification ( $f_{PC} = 38.375\text{ MHz}$ ;  $f_{SC} = 32.875\text{ MHz}$ ;  $PC / SC = 13\text{ dB}$ ;  $f_{AF} = 400\text{ Hz}$ ); input level  $V_{i(IF)} = 10\text{ mV (RMS)}$  (sync level for B/G; peak white level for L); IF input from  $50\ \Omega$  via broadband transformer 1 : 1; video modulation: Vestigial SideBand (VSB); residual carrier for B/G is 10 % and for L is 3 %; video signal in accordance with "ITU-T J.63 line 17 and line 330" or "NTC-7 Composite"; internal Nyquist slope switched on ( $W7[0] = 0$ ); not dual mode; measurements taken in test circuit of [Figure 49](#); unless otherwise specified.

Symbol	Parameter	Conditions	Min	Typ	Max	Unit	
$\alpha_{CC}$	color carrier attenuation	QSS mode; BP selection for standard					
		M/N; $f_{CC} = 3.58\text{ MHz}$	15	23	-	dB	
		B/G; $f_{CC} = 4.43\text{ MHz}$	22	30	-	dB	
		I; $f_{CC} = 4.43\text{ MHz}$	20	28	-	dB	
		D/K; $f_{CC} = 4.28\text{ MHz}$	20	28	-	dB	
		L/L-accent; $f_{CC} = 4.28\text{ MHz}$	20	28	-	dB	
		TSS mode; BP selection for standard					
		M/N; $f_{CC} = 5.42\text{ MHz}$	15	23	-	dB	
		B/G; $f_{CC} = 6.57\text{ MHz}$	22	30	-	dB	
		I; $f_{CC} = 7.57\text{ MHz}$	20	25	-	dB	
L/L-accent; $f_{CC} = 8.72\text{ MHz}$	20	28	-	dB			

**External filter output; pin EXTFILO**

$V_{EXTFILO}$	voltage on pin EXTFILO (DC)		1.8	2.0	2.2	V
$V_{EXTFILO(p-p)}$	peak-to-peak voltage on pin EXTFILO	IF intercarrier; SC1 on; SC2 off	420	620	820	mV
		IF intercarrier; L standard; without modulation				
		W7[5] = 0	210	310	410	mV
		W7[5] = 1	105	155	205	mV
$I_{o(max)}$	maximum output current	AC and DC	1	-	-	mA

**FM PLL demodulator**

$f_{FMPLL}$	FM PLL frequency	see <a href="#">Table 18</a> and <a href="#">Table 21</a>	-	4.5	-	MHz
			-	5.5	-	MHz
			-	6.0	-	MHz
			-	6.5	-	MHz
			-	10.7	-	MHz

**FM PLL filter; pin LFFM**

$V_{LFFM}$	voltage on pin LFFM	$f_{FMPLL} = 4.5\text{ MHz}$	1.5	1.9	3.3	V
		$f_{FMPLL} = 5.5\text{ MHz}$	1.5	2.2	3.3	V
		$f_{FMPLL} = 6.0\text{ MHz}$	1.5	2.35	3.3	V
		$f_{FMPLL} = 6.5\text{ MHz}$	1.5	2.5	3.3	V
		$f_{FMPLL} = 10.7\text{ MHz}$	1.5	2.4	3.3	V
$T_{cy(dah)}$	digital acquisition help cycle time		-	64	-	$\mu\text{s}$

**Table 55. Characteristics ...continued**

$V_P = 5\text{ V}$ ;  $T_{amb} = 25\text{ °C}$ ; see [Table 26](#) for input frequencies; B/G standard is used for the specification ( $f_{PC} = 38.375\text{ MHz}$ ;  $f_{SC} = 32.875\text{ MHz}$ ;  $PC / SC = 13\text{ dB}$ ;  $f_{AF} = 400\text{ Hz}$ ); input level  $V_{i(IF)} = 10\text{ mV (RMS)}$  (sync level for B/G; peak white level for L); IF input from  $50\text{ }\Omega$  via broadband transformer 1 : 1; video modulation: Vestigial SideBand (VSB); residual carrier for B/G is 10 % and for L is 3 %; video signal in accordance with "ITU-T J.63 line 17 and line 330" or "NTC-7 Composite"; internal Nyquist slope switched on ( $W7[0] = 0$ ); not dual mode; measurements taken in test circuit of [Figure 49](#); unless otherwise specified.

Symbol	Parameter	Conditions	Min	Typ	Max	Unit
$t_{w(dah)}$	digital acquisition help pulse width		-	16	-	$\mu\text{s}$
$I_{o(dah)}$	digital acquisition help output current	sink or source				
		$W3[4] = 0$ ; $W6[3] = 0$ ; FM window width = 237.5 kHz	14	18	22	$\mu\text{A}$
		$W3[4] = 1$ ; $W6[3] = 0$ ; FM window width = 475 kHz	28	36	44	$\mu\text{A}$
		$W3[4] = 0$ ; $W6[3] = 1$ ; FM window width = 1 MHz	14	18	22	$\mu\text{A}$
		$W3[4] = 1$ ; $W6[3] = 1$ ; FM window width = 1 MHz	28	36	44	$\mu\text{A}$
$K_{D(FM)}$	FM phase detector steepness	$\Delta f_{FMPLL} / \Delta \phi_{VCO(FM)}$				
		$W3[4] = 0$ ; $W6[3] = 0$ ; FM window width = 237.5 kHz	-	4	-	$\mu\text{A/rad}$
		$W3[4] = 1$ ; $W6[3] = 0$ ; FM window width = 475 kHz	-	10	-	$\mu\text{A/rad}$
		$W3[4] = 0$ ; $W6[3] = 1$ ; FM window width = 1 MHz	-	4	-	$\mu\text{A/rad}$
		$W3[4] = 1$ ; $W6[3] = 1$ ; FM window width = 1 MHz	-	10	-	$\mu\text{A/rad}$
$K_{O(FM)}$	FM VCO steepness	$\Delta f_{FMPLL} / \Delta V_{LFFM}$				
		$f < 10\text{ MHz}$	-	3.3	-	$\text{MHz/V}$
		$f = 10.7\text{ MHz}$	-	5.9	-	$\text{MHz/V}$
$I_{offset(FM)}$	FM offset current	$W6[3] = 0$ ; $W3[4] = 0$	-1.5	0	+1.5	$\mu\text{A}$
		$W6[3] = 0$ ; $W3[4] = 1$	-2.5	0	+2.5	$\mu\text{A}$
<b>FM intercarrier input; pins EXTFMI and EXTFILI; see <a href="#">Figure 14</a></b>						
$ Z_i $	input impedance	AC-coupled via 4 pF	-	20	-	$\text{k}\Omega$
$V_{i(FM)(RMS)}$	RMS FM input voltage	gain controlled operation; $W1[1:0] = 10$ or $W1[1:0] = 11$ or $W1[1:0] = 01$	2	-	300	$\text{mV}$
$V_{lock(min)(RMS)}$	RMS minimum lock-in voltage	$W1[1:0] = 10$ or $W1[1:0] = 11$ or $W1[1:0] = 01$	-	-	1.5	$\text{mV}$

**Table 55. Characteristics ...continued**

$V_P = 5\text{ V}$ ;  $T_{amb} = 25\text{ °C}$ ; see [Table 26](#) for input frequencies; B/G standard is used for the specification ( $f_{PC} = 38.375\text{ MHz}$ ;  $f_{SC} = 32.875\text{ MHz}$ ;  $PC / SC = 13\text{ dB}$ ;  $f_{AF} = 400\text{ Hz}$ ); input level  $V_{i(IF)} = 10\text{ mV (RMS)}$  (sync level for B/G; peak white level for L); IF input from  $50\text{ }\Omega$  via broadband transformer 1 : 1; video modulation: Vestigial SideBand (VSB); residual carrier for B/G is 10 % and for L is 3 %; video signal in accordance with "ITU-T J.63 line 17 and line 330" or "NTC-7 Composite"; internal Nyquist slope switched on ( $W7[0] = 0$ ); not dual mode; measurements taken in test circuit of [Figure 49](#); unless otherwise specified.

Symbol	Parameter	Conditions	Min	Typ	Max	Unit
$V_{det(FM)min(RMS)}$	RMS minimum FM carrier detection voltage	W1[1:0] = 10 or W1[1:0] = 11 or W1[1:0] = 01	-	-	1.8	mV
<b>FM demodulator part; audio output; pin AUD</b>						
$V_{o(AF)(RMS)}$	RMS AF output voltage	QSS or TSS mode; 25 kHz FM deviation; 75 $\mu$ s de-emphasis	400	500	600	mV
		QSS or TSS mode; 27 kHz FM deviation; 50 $\mu$ s de-emphasis	430	540	650	mV
		QSS or TSS mode; 55 kHz FM deviation; 50 $\mu$ s de-emphasis	900	-	1300	mV
		radio mode; 22.5 kHz FM deviation; 75 $\mu$ s de-emphasis	360	450	540	mV
$\Delta V_{o(AF)/\Delta T}$	AF output voltage variation with temperature		-	$3 \times 10^{-3}$	$7 \times 10^{-3}$	dB/K
THD	total harmonic distortion	50 $\mu$ s de-emphasis; FM deviation: for TV mode 27 kHz and for radio mode 22.5 kHz	-	0.15	0.50	%
$\Delta f_{AF(max)}$	maximum AF frequency deviation	THD < 2 %; pre-emphasis off; $f_{AF} = 400\text{ Hz}$	[18]			
		W3[1:0] = 00 (audio gain = 0 dB)	$\pm 55$	-	-	kHz
		W3[1:0] = 01 (audio gain = -6 dB)	$\pm 110$	-	-	kHz
		W3[1:0] = 10 (audio gain = -12 dB)	$\pm 170$	-	-	kHz
		W3[1:0] = 11 (audio gain = -18 dB) and W3[4] = 1 (FM window width = 475 kHz)	$\pm 380$	-	-	kHz
$f_{AF(max)}$	maximum AF frequency	THD < 2 %; pre-emphasis off	[3]			
		FM window width = 237.5 kHz; -6 dB audio gain; FM deviation 100 kHz	15	-	-	kHz
		FM window width = 475 kHz; -18 dB audio gain; FM deviation 300 kHz	15	-	-	kHz

**Table 55. Characteristics ...continued**

$V_P = 5\text{ V}$ ;  $T_{amb} = 25\text{ °C}$ ; see [Table 26](#) for input frequencies; B/G standard is used for the specification ( $f_{PC} = 38.375\text{ MHz}$ ;  $f_{SC} = 32.875\text{ MHz}$ ;  $PC / SC = 13\text{ dB}$ ;  $f_{AF} = 400\text{ Hz}$ ); input level  $V_{i(IF)} = 10\text{ mV (RMS)}$  (sync level for B/G; peak white level for L); IF input from  $50\text{ }\Omega$  via broadband transformer 1 : 1; video modulation: Vestigial SideBand (VSB); residual carrier for B/G is 10 % and for L is 3 %; video signal in accordance with "ITU-T J.63 line 17 and line 330" or "NTC-7 Composite"; internal Nyquist slope switched on ( $W7[0] = 0$ ); not dual mode; measurements taken in test circuit of [Figure 49](#); unless otherwise specified.

Symbol	Parameter	Conditions	Min	Typ	Max	Unit
$f_{-3dB(AF)}$	AF cut-off frequency	W3[2] = 0; W3[4] = 0; without de-emphasis; FM window width = 237.5 kHz	80	100	-	kHz
$(S/N)_{w(AF)}$	AF weighted signal-to-noise ratio	27 kHz FM deviation; 50 $\mu$ s de-emphasis; vision carrier unmodulated; FM PLL only; "ITU-R BS.468-4"	48	56	-	dB
$(S/N)_{unw(AF)}$	AF unweighted signal-to-noise ratio	radio mode (10.7 MHz); 22.5 kHz FM deviation; 75 $\mu$ s de-emphasis	-	58	-	dB
$V_{SC(rsD)(RMS)}$	RMS residual sound carrier voltage	fundamental wave and harmonics; without de-emphasis	-	-	2	mV
$\alpha_{AM}$	AM suppression	referenced to 27 kHz FM deviation; 50 $\mu$ s de-emphasis; AM: $f = 1\text{ kHz}$ ; $m = 54\%$	35	46	-	dB
PSRR	power supply ripple rejection	$f_{ripple} = 70\text{ Hz}$ ; see <a href="#">Figure 9</a>	14	20	-	dB

**Audio amplifier**

Audio output; pin AUD

$R_O$	output resistance		[3]	-	-	300	$\Omega$	
$V_O$	output voltage			2.0	2.4	2.7	V	
$R_L$	load resistance	AC-coupled	[3]	10	-	-	k $\Omega$	
		DC-coupled	[3]	100	-	-	k $\Omega$	
$C_L$	load capacitance		[3]	-	-	1	nF	
$V_{o(AF)(RMS)}$	RMS AF output voltage	25 kHz FM deviation; 75 $\mu$ s de-emphasis; see <a href="#">Table 29</a>						
		0 dB		400	500	600	mV	
		-6 dB		-	250	-	mV	
		-12 dB		-	125	-	mV	
		-18 dB		-	62.5	-	mV	
		AM; $m = 54\%$ ; see <a href="#">Table 29</a>						
		0 dB		400	500	600	mV	
-6 dB		-	250	-	mV			

**Table 55. Characteristics ...continued**

$V_P = 5\text{ V}$ ;  $T_{amb} = 25\text{ }^\circ\text{C}$ ; see [Table 26](#) for input frequencies; B/G standard is used for the specification ( $f_{PC} = 38.375\text{ MHz}$ ;  $f_{SC} = 32.875\text{ MHz}$ ;  $PC / SC = 13\text{ dB}$ ;  $f_{AF} = 400\text{ Hz}$ ); input level  $V_{i(IF)} = 10\text{ mV (RMS)}$  (sync level for B/G; peak white level for L); IF input from  $50\text{ }\Omega$  via broadband transformer 1 : 1; video modulation: Vestigial SideBand (VSB); residual carrier for B/G is 10 % and for L is 3 %; video signal in accordance with "ITU-T J.63 line 17 and line 330" or "NTC-7 Composite"; internal Nyquist slope switched on ( $W7[0] = 0$ ); not dual mode; measurements taken in test circuit of [Figure 49](#); unless otherwise specified.

Symbol	Parameter	Conditions	Min	Typ	Max	Unit	
$f_{-3dB(AF)u}$	upper AF cut-off frequency	$W3[2] = 0$ (without de-emphasis); see <a href="#">Figure 33</a> and <a href="#">Figure 34</a>	[19]				
		$W6[1] = 0$ (audio processing off)	-	150	-	kHz	
		$W6[1] = 1$ (audio processing on); no interference	-	26	-	kHz	
		$W6[1] = 1$ (audio processing on); interference at 90 kHz AF and 40 kHz FM deviation	-	1.7	-	kHz	
$f_{-3dB(AF)l}$	lower AF cut-off frequency	$W3[2] = 0$ (without de-emphasis); see <a href="#">Figure 33</a> and <a href="#">Figure 34</a>	[19]				
		$W6[1] = 0$ (audio processing off)	[20]	-	20	-	Hz
		$W6[1] = 1$ (audio processing on); no interference	-	16	-	Hz	
		$W6[1] = 1$ (audio processing on); interference at 90 kHz AF and 40 kHz FM deviation	-	240	-	Hz	
$\alpha_{660Hz}$	attenuation at 660 Hz	$W3[2] = 0$ (without de-emphasis); $W6[1] = 1$ (audio processing on); interference at 90 kHz AF and 40 kHz FM deviation; see <a href="#">Figure 33</a> and <a href="#">Figure 34</a>	[19]	-	28	-	dB
$\alpha_{mute}$	mute attenuation	of AF signal		70	-	-	dB

**Table 55. Characteristics ...continued**

$V_P = 5\text{ V}$ ;  $T_{amb} = 25\text{ °C}$ ; see [Table 26](#) for input frequencies; B/G standard is used for the specification ( $f_{PC} = 38.375\text{ MHz}$ ;  $f_{SC} = 32.875\text{ MHz}$ ;  $PC / SC = 13\text{ dB}$ ;  $f_{AF} = 400\text{ Hz}$ ); input level  $V_{i(IF)} = 10\text{ mV (RMS)}$  (sync level for B/G; peak white level for L); IF input from  $50\text{ }\Omega$  via broadband transformer 1 : 1; video modulation: Vestigial SideBand (VSB); residual carrier for B/G is 10 % and for L is 3 %; video signal in accordance with "ITU-T J.63 line 17 and line 330" or "NTC-7 Composite"; internal Nyquist slope switched on ( $W7[0] = 0$ ); not dual mode; measurements taken in test circuit of [Figure 49](#); unless otherwise specified.

Symbol	Parameter	Conditions	Min	Typ	Max	Unit
$\Delta V_{\text{jmp}}$	jump voltage difference (DC)	switching AF output to mute state or vice versa; activated by digital acquisition help $W3[6] = 1$ or via $W3[5]$	-	$\pm 50$	$\pm 150$	mV
		switching audio processing on/off or vice versa; $W6[1] = 0/1$ transition	-350	-	+350	mV
		audio processing controlled by switching from no interference to interference or vice versa; $W6[1] = 1$ ; interference at 90 kHz AF and 40 kHz FM deviation	-150	-	+150	mV
PSRR	power supply ripple rejection	$f_{\text{ripple}} = 70\text{ Hz}$ ; see <a href="#">Figure 9</a>	14	20	-	dB
<b>De-emphasis network; pin CDEEM</b>						
$V_O$	output voltage		-	2.4	-	V
$R_O$	output resistance	$W3[3:2] = 11$ (50 $\mu\text{s}$ de-emphasis)	8.5	-	14	k $\Omega$
		$W3[3:2] = 01$ (75 $\mu\text{s}$ de-emphasis)	13	-	21	k $\Omega$
$V_{AF(RMS)}$	RMS AF voltage	$f_{AF} = 400\text{ Hz}$ ; $V_{O(AF)} = 500\text{ mV (RMS)}$ ; 0 dB attenuation	-	170	-	mV
<b>AF decoupling; pin CAF</b>						
$V_{\text{dec}}$	decoupling voltage (DC)	$f_{\text{FMPLL}} = 4.5\text{ MHz}$	1.5	1.9	3.3	V
		$f_{\text{FMPLL}} = 5.5\text{ MHz}$	1.5	2.2	3.3	V
		$f_{\text{FMPLL}} = 6.0\text{ MHz}$	1.5	2.35	3.3	V
		$f_{\text{FMPLL}} = 6.5\text{ MHz}$	1.5	2.5	3.3	V
		$f_{\text{FMPLL}} = 10.7\text{ MHz}$	1.5	2.4	3.3	V
$I_L$	leakage current	$\Delta V_{\text{AUD}} < \pm 50\text{ mV (p-p)}$ ; 0 dB attenuation	-	-	$\pm 25$	nA
$I_{O(\text{max})}$	maximum output current	sink or source	1.15	1.5	1.85	$\mu\text{A}$
<b>Audio processing capacitor for soft mute and low cut; pin APCLC</b>						
$V_O$	output voltage		-	2.4	-	V
$I_L$	leakage current		-	-	6	nA



**Table 55. Characteristics ...continued**

$V_P = 5\text{ V}$ ;  $T_{amb} = 25\text{ }^\circ\text{C}$ ; see [Table 26](#) for input frequencies; B/G standard is used for the specification ( $f_{PC} = 38.375\text{ MHz}$ ;  $f_{SC} = 32.875\text{ MHz}$ ;  $PC / SC = 13\text{ dB}$ ;  $f_{AF} = 400\text{ Hz}$ ); input level  $V_{i(IF)} = 10\text{ mV (RMS)}$  (sync level for B/G; peak white level for L); IF input from  $50\ \Omega$  via broadband transformer 1 : 1; video modulation: Vestigial SideBand (VSB); residual carrier for B/G is 10 % and for L is 3 %; video signal in accordance with "ITU-T J.63 line 17 and line 330" or "NTC-7 Composite"; internal Nyquist slope switched on ( $W7[0] = 0$ ); not dual mode; measurements taken in test circuit of [Figure 49](#); unless otherwise specified.

Symbol	Parameter	Conditions	Min	Typ	Max	Unit
Audio processing capacitor for high cut; pin APCHC						
$V_O$	output voltage		-	2.4	-	V
$I_L$	leakage current		-	-	6	nA

**FM operation**<sup>[21][22]</sup>

Single reference QSS AF performance; pin AUD<sup>[23]</sup>

$(S/N)_{w(SC1)}$	first sound carrier weighted signal-to-noise ratio	PC / SC1 > 40 dB at pins IF1A and IF1B or IF2A and IF2B; 27 kHz FM deviation; BP off; "ITU-R BS.468-4"					
			black picture	45	50	-	dB
			white picture	45	50	-	dB
			6 kHz sine wave (black-to-white modulation)	43	47	-	dB
			250 kHz square wave (black-to-white modulation)	45	50	-	dB

Single reference QSS AF performance with external FM demodulator connected to OUT1A and OUT1B<sup>[24]</sup>

$(S/N)_{w(SC1)}$	first sound carrier weighted signal-to-noise ratio	PC / SC1 > 40 dB at pins IF1A and IF1B or IF2A and IF2B; 27 kHz FM deviation; BP off; "ITU-R BS.468-4"					
			black picture	53	58	-	dB
			white picture	50	53	-	dB
			6 kHz sine wave (black-to-white modulation)	44	48	-	dB
			250 kHz square wave (black-to-white modulation)	40	45	-	dB
			sound carrier subharmonics; $f = 2.75\text{ MHz} \pm 3\text{ kHz}$	45	51	-	dB
			sound carrier subharmonics; $f = 2.87\text{ MHz} \pm 3\text{ kHz}$	46	52	-	dB

**Table 55. Characteristics ...continued**

$V_P = 5\text{ V}$ ;  $T_{amb} = 25\text{ °C}$ ; see [Table 26](#) for input frequencies; B/G standard is used for the specification ( $f_{PC} = 38.375\text{ MHz}$ ;  $f_{SC} = 32.875\text{ MHz}$ ;  $PC / SC = 13\text{ dB}$ ;  $f_{AF} = 400\text{ Hz}$ ); input level  $V_{i(IF)} = 10\text{ mV (RMS)}$  (sync level for B/G; peak white level for L); IF input from  $50\text{ }\Omega$  via broadband transformer 1 : 1; video modulation: Vestigial SideBand (VSB); residual carrier for B/G is 10 % and for L is 3 %; video signal in accordance with "ITU-T J.63 line 17 and line 330" or "NTC-7 Composite"; internal Nyquist slope switched on ( $W7[0] = 0$ ); not dual mode; measurements taken in test circuit of [Figure 49](#); unless otherwise specified.

Symbol	Parameter	Conditions	Min	Typ	Max	Unit
$(S/N)_{w(SC2)}$	second sound carrier weighted signal-to-noise ratio	with external reference FM demodulator; PC / SC2 > 40 dB at pins IF1A and IF1B or IF2A and IF2B; 27 kHz (54 % FM deviation); BP off; "ITU-R BS.468-4"				
		black picture	48	55	-	dB
		white picture	46	51	-	dB
		6 kHz sine wave (black-to-white modulation)	42	46	-	dB
		250 kHz square wave (black-to-white modulation)	29	34	-	dB
		sound carrier subharmonics; $f = 2.75\text{ MHz} \pm 3\text{ kHz}$	44	50	-	dB
		sound carrier subharmonics; $f = 2.87\text{ MHz} \pm 3\text{ kHz}$	45	51	-	dB

**AM operation**

L standard; pin AUD

$V_{o(AF)(RMS)}$	RMS AF output voltage	54 % modulation	400	500	600	mV	
THD	total harmonic distortion	54 % modulation; BP on; see <a href="#">Figure 32</a>	-	0.5	1.0	%	
$B_{AF(-3dB)}$	-3 dB AF bandwidth		12	18	-	kHz	
$(S/N)_{w(AF)}$	AF weighted signal-to-noise ratio	"ITU-R BS.468-4"					
		BP on	38	42	-	dB	
		BP off	44	50	-	dB	
		composite IF; VIF modulation = color bar; "ITU-R BS.468-4"; BP on	[3]	-	40	-	dB

**Diversity output; pin DIV**

$V_{o(video)(p-p)}$	peak-to-peak video output voltage		[25] 0.8	1.0	1.2	V
$V_{whl(DIV)}$	white level voltage on pin DIV	10 % residual carrier	[25] 3.2	3.4	3.6	V
$f_{-3dB(u)}$	upper cut-off frequency		-	300	-	kHz
$I_{o(max)}$	maximum output current	AC and DC; sink or source	1	-	-	mA

**Table 55. Characteristics ...continued**

$V_P = 5\text{ V}$ ;  $T_{amb} = 25\text{ }^\circ\text{C}$ ; see [Table 26](#) for input frequencies; B/G standard is used for the specification ( $f_{PC} = 38.375\text{ MHz}$ ;  $f_{SC} = 32.875\text{ MHz}$ ;  $PC / SC = 13\text{ dB}$ ;  $f_{AF} = 400\text{ Hz}$ ); input level  $V_{i(IF)} = 10\text{ mV (RMS)}$  (sync level for B/G; peak white level for L); IF input from  $50\text{ }\Omega$  via broadband transformer 1 : 1; video modulation: Vestigial SideBand (VSB); residual carrier for B/G is 10 % and for L is 3 %; video signal in accordance with "ITU-T J.63 line 17 and line 330" or "NTC-7 Composite"; internal Nyquist slope switched on ( $W7[0] = 0$ ); not dual mode; measurements taken in test circuit of [Figure 49](#); unless otherwise specified.

Symbol	Parameter	Conditions	Min	Typ	Max	Unit
<b>Reference frequency</b>						
<b>General</b>						
$f_{ref}$	reference frequency		[26] -	4	-	MHz
<b>Reference frequency generation with crystal; pin OPTXTAL</b>						
$V_{OPTXTAL}$	voltage on pin OPTXTAL (DC)	pin open-circuit	2.3	2.6	2.9	V
$R_i$	input resistance		[3] -	2	-	k $\Omega$
$R_{rsn(xtal)}$	crystal resonance resistance		-	-	200	$\Omega$
$C_{pull}$	pull capacitance		[27] -	-	-	pF
$R_{swoff(OPTXTAL)}$	switch-off resistance on pin OPTXTAL	to switch off crystal input by external resistor wired between pin OPTXTAL and GND	0.22	-	4.7	k $\Omega$
$I_{swoff}$	switch-off current	$R_{swoff(OPTXTAL)} = 0.22\text{ k}\Omega$	-	-	1600	$\mu\text{A}$
		$R_{swoff(OPTXTAL)} = 3.3\text{ k}\Omega$	-	500	-	$\mu\text{A}$
<b>Reference frequency input from external source; pin OPTXTAL</b>						
$V_{OPTXTAL}$	voltage on pin OPTXTAL (DC)	pin open-circuit	2.3	2.6	2.9	V
$R_i$	input resistance		[3] -	2	-	k $\Omega$
$V_{ref(RMS)}$	RMS reference voltage		80	-	400	mV
$R_O$	output resistance	of external reference signal source	[3] -	2	4.7	k $\Omega$
$C_{dec}$	decoupling capacitance	to external reference signal source	[3] 22	100	-	pF
<b>Reference frequency input from external source; <math>W7[7] = 0</math>; pin FREF</b>						
$V_{FREF}$	voltage on pin FREF (DC)	pin open-circuit	2.2	2.5	2.8	V
$R_i$	input resistance		[3] 50	-	-	k $\Omega$
$f_{ref}$	reference frequency		[26] -	4	-	MHz
$V_{ref(RMS)}$	RMS reference voltage	see <a href="#">Figure 35</a>	15	150	500	mV
$R_O$	output resistance	of external reference signal source; AC-coupled	-	-	4.7	k $\Omega$
$C_{dec}$	decoupling capacitance	to external reference signal source	22	100	-	pF
$R_{swoff(FREF)}$	switch-off resistance on pin FREF	to switch off reference signal input by external resistor wired between pin FREF and GND	3.9	-	27	k $\Omega$
$I_{swoff}$	switch-off current	$R_{swoff(FREF)} = 3.9\text{ k}\Omega$	-	-	100	$\mu\text{A}$
		$R_{swoff(FREF)} = 22\text{ k}\Omega$	-	75	-	$\mu\text{A}$

**Table 55. Characteristics ...continued**

$V_P = 5\text{ V}$ ;  $T_{amb} = 25\text{ °C}$ ; see [Table 26](#) for input frequencies; B/G standard is used for the specification ( $f_{PC} = 38.375\text{ MHz}$ ;  $f_{SC} = 32.875\text{ MHz}$ ;  $PC / SC = 13\text{ dB}$ ;  $f_{AF} = 400\text{ Hz}$ ); input level  $V_{i(IF)} = 10\text{ mV (RMS)}$  (sync level for B/G; peak white level for L); IF input from  $50\text{ }\Omega$  via broadband transformer 1 : 1; video modulation: Vestigial SideBand (VSB); residual carrier for B/G is 10 % and for L is 3 %; video signal in accordance with "ITU-T J.63 line 17 and line 330" or "NTC-7 Composite"; internal Nyquist slope switched on ( $W7[0] = 0$ ); not dual mode; measurements taken in test circuit of [Figure 49](#); unless otherwise specified.

Symbol	Parameter	Conditions	Min	Typ	Max	Unit
<b>Reference frequency output; W7[7] = 1; pin FREF</b>						
$V_{FREF}$	voltage on pin FREF (DC)	pin open-circuit	2.3	2.6	2.9	V
$R_O$	output resistance		[3] 200	350	500	$\Omega$
$V_{o(fref)(p-p)}$	peak-to-peak reference frequency output voltage	pin open-circuit	[3] 200	300	360	mV
$f_{-3dB(u)}$	upper cut-off frequency		[3] 4	8	12	MHz
$I_{bias(int)}$	internal bias current (DC)	of emitter follower	[3] 150	200	-	$\mu\text{A}$
$I_{sink(o)(max)}$	maximum output sink current	AC and DC	[3] 100	-	-	$\mu\text{A}$
$I_{source(o)(max)}$	maximum output source current	AC and DC	[3] 430	-	-	$\mu\text{A}$
<b>I<sup>2</sup>C-bus transceiver[28]</b>						
<b>Address select; pin ADRSEL</b>						
$V_{ADRSEL}$	voltage on pin ADRSEL (DC)	pin open-circuit	-	$0.5V_P$	-	V
		for address select				
		MAD1; pin connected to GND	0	-	$0.04V_P$	V
		MAD3; pin connected to GND via $R_{ADRSEL}$	$0.12V_P$	-	$0.30V_P$	V
		MAD4; pin connected to $V_P$ via $R_{ADRSEL}$	$0.66V_P$	-	$0.86V_P$	V
		MAD2; pin connected to $V_P$	$0.96V_P$	-	$V_P$	V
$R_i$	input resistance		[3] -	35	-	$k\Omega$
$R_{ADRSEL}$	resistance on pin ADRSEL		42.3	47	51.7	$k\Omega$
<b>I<sup>2</sup>C-bus voltage select; pin BVS</b>						
$V_{BVS}$	voltage on pin BVS (DC)	pin open-circuit	-	$0.52V_P$	-	V
$I_{sink(l)}$	input sink current	pin connected to $V_P$	-	-	10	$\mu\text{A}$
$I_{source(l)}$	input source current	pin connected to GND	-	-	60	$\mu\text{A}$
$V_I$	input voltage	$V_{CC(I2C-bus)} = 5.0\text{ V}$ ; pin connected to $V_P$	$0.88V_P$	-	$V_P$	V
		$V_{CC(I2C-bus)} = 3.3\text{ V}$ ; pin open-circuit	$0.46V_P$	-	$0.58V_P$	V
		$V_{CC(I2C-bus)} = 2.5\text{ V}$ ; pin connected to GND	0	-	$0.12V_P$	V
<b>I<sup>2</sup>C-bus transceiver; pins SCL and SDA[29]</b>						
$V_{IH}$	HIGH-level input voltage	$V_{CC(I2C-bus)} = 5.0\text{ V}$	[30] $0.6V_P$	-	$V_P$	V
		$V_{CC(I2C-bus)} = 3.3\text{ V}$	[31] 2.3	-	$V_P$	V
		$V_{CC(I2C-bus)} = 2.5\text{ V}$	[31] 1.75	-	$V_P$	V

**Table 55. Characteristics ...continued**

$V_P = 5\text{ V}$ ;  $T_{amb} = 25\text{ }^\circ\text{C}$ ; see [Table 26](#) for input frequencies; B/G standard is used for the specification ( $f_{PC} = 38.375\text{ MHz}$ ;  $f_{SC} = 32.875\text{ MHz}$ ;  $PC / SC = 13\text{ dB}$ ;  $f_{AF} = 400\text{ Hz}$ ); input level  $V_{i(IF)} = 10\text{ mV (RMS)}$  (sync level for B/G; peak white level for L); IF input from  $50\text{ }\Omega$  via broadband transformer 1 : 1; video modulation: Vestigial SideBand (VSB); residual carrier for B/G is 10 % and for L is 3 %; video signal in accordance with "ITU-T J.63 line 17 and line 330" or "NTC-7 Composite"; internal Nyquist slope switched on ( $W7[0] = 0$ ); not dual mode; measurements taken in test circuit of [Figure 49](#); unless otherwise specified.

Symbol	Parameter	Conditions	Min	Typ	Max	Unit	
$V_{IL}$	LOW-level input voltage	$V_{CC(I2C-bus)} = 5.0\text{ V}$	[30]	-0.3	-	+0.3V <sub>P</sub>	V
		$V_{CC(I2C-bus)} = 3.3\text{ V}$	[31]	-0.3	-	+1.0	V
		$V_{CC(I2C-bus)} = 2.5\text{ V}$	[31]	-0.3	-	+0.75	V
$I_{IH}$	HIGH-level input current		-10	-	+10	$\mu\text{A}$	
$I_{IL}$	LOW-level input current		-10	-	+10	$\mu\text{A}$	
$V_{OL}$	LOW-level output voltage	$I_{OL} = 3\text{ mA}$ ; for data transmission (SDA)	-	-	0.4	V	
$f_{SCL}$	SCL clock frequency		0	-	400	kHz	

- [1] Values of video and sound parameters can be decreased at  $V_P = 4.5\text{ V}$ .
- [2] Condition for secure POR is a rise or fall time greater than  $2\text{ }\mu\text{s}$ .
- [3] This parameter is not tested during the production and is only given as application information for designing the receiver circuit.
- [4] Level headroom for input level jumps during gain control setting.
- [5]  $B_{LF(-3dB)} = 100\text{ kHz}$  (damping factor  $d = 1.9$ ; calculated with sync level within gain control range). Calculation of the VIF PLL filter can be done by use of the following formula:

$$B_{LF(-3dB)} = \frac{1}{2\pi} K_O K_D R, \text{ valid for } d \geq 1.2$$

$$d = \frac{1}{2} R \sqrt{K_O K_D C},$$

where:

$K_O$  is the VCO steepness  $\left(\frac{\text{rad}}{\text{sV}}\right)$  or  $\left(2\pi\frac{\text{Hz}}{\text{V}}\right)$ ;  $K_D$  is the phase detector steepness  $\left(\frac{\text{A}}{\text{rad}}\right)$ ;

R is the loop filter serial resistor ( $\Omega$ ); C is the loop filter serial capacitor (F);  $B_{LF(-3dB)}$  is the -3 dB LF bandwidth (Hz); d is the damping factor.

- [6] The VCO frequency offset related to the PC frequency is set to 1 MHz with white picture video modulation.
- [7] AC load;  $C_L < 20\text{ pF}$  and  $R_L > 1\text{ k}\Omega$ . The sound carrier frequencies (depending on TV standard) are attenuated by the integrated sound carrier traps.
- [8] Condition: luminance range (5 steps) from 0 % to 100 %. Measurement value is based on 4 of 5 steps.
- [9] Measurement using 200 kHz high-pass filter, 5 MHz low-pass filter and subcarrier notch filter ("ITU-T J.64").
- [10] Modulation VSB; sound carrier off;  $f_{video} > 0.5\text{ MHz}$ .
- [11] Sound carrier on;  $f_{video} = 10\text{ kHz}$  to 10 MHz.
- [12] The sound carrier trap can be bypassed by setting the I<sup>2</sup>C-bus bit W2[0] to logic 0; see [Table 25](#). In this way the full composite video spectrum appears at pin CVBS. The video amplitude is reduced to 1.1 V (p-p).
- [13] Measurement condition: with transformer, transmitter pre-correction on; reference is at 1 MHz.
- [14] The response time is valid for a VIF input level range from 200  $\mu\text{V}$  to 70 mV.
- [15] See [Figure 18](#) to smooth current pulses.
- [16] To match the AFC output signal to different tuning systems a current output is provided. The test circuit is given in [Figure 18](#). The AFC steepness can be changed by resistors R1 and R2.
- [17] The AFC value of the VIF and RIF frequency is generated by using digital counting methods. The used counter resolution is provided with an uncertainty of  $\pm 1$  bit corresponding to  $\pm 25\text{ kHz}$ . This uncertainty of  $\pm 25\text{ kHz}$  has to be added to the frequency accuracy parameter.

- [18] Measured with an FM deviation of 25 kHz and the typical AF output voltage of 500 mV (RMS). The audio signal processing stage provides headroom of 6 dB with THD < 1.5 %. The I<sup>2</sup>C-bus bits W3[0] and W3[1] control the AF output signal amplitude from 0 dB to -18 dB in steps of -6 dB. Reducing the audio gain for handling a frequency deviation of more than 55 kHz avoids AF output signal clipping.
- [19] Amplitude response depends on dimensioning of FM PLL loop filter and components at pin APCLC and pin APCHC.
- [20] The lower AF cut-off frequency depends on the value of the capacitor at pin CAF. A value of C<sub>AF</sub> = 470 nF leads to f<sub>-3dB(AF)</sub> ≈ 20 Hz and C<sub>AF</sub> = 220 nF leads to f<sub>-3dB(AF)</sub> ≈ 40 Hz.
- [21] For all signal-to-noise measurements the used VIF modulator has to meet the following specifications:
  - a) Incidental phase modulation for black-to-white jump less than 0.5 degrees.
  - b) QSS AF performance, measured with the television demodulator AMF2 (audio output, weighted signal-to-noise ratio) better than 60 dB (at deviation 27 kHz) for 6 kHz sine wave black-to-white video modulation.
  - c) Picture-to-sound carrier ratio PC / SC1 = 13 dB (transmitter).
- [22] The PC / SC ratio is calculated as the addition of TV transmitter PC / SC1 ratio and SAW filter PC / SC1 ratio. This PC / SC ratio is necessary to achieve the weighted signal-to-noise values as noted. A different PC / SC ratio will change these values.
- [23] Measurement condition is SC1 / SC2 ≥ 7 dB.
- [24] The differential QSS signal output on pins OUT1A and OUT1B is analyzed by a test demodulator TDA9820. The signal-to-noise ratio of this device is better than 60 dB. The measurement is related to an FM deviation of ±27 kHz and in accordance with "ITU-R BS.468-4".
- [25] Sound carrier not present.
- [26] The tolerance of the reference frequency determines the accuracy of VIF AFC, RIF AFC, FM demodulator center frequency, maximum FM deviation, sound trap frequency, LIF band-pass cut-off frequency and ZIF low-pass cut-off frequency as well as the accuracy of the synthesizer.
- [27] The value of C<sub>pull</sub> determines the accuracy of the resonance frequency of the crystal. It depends on the used type of crystal.
- [28] The AC characteristics are in accordance with the I<sup>2</sup>C-bus specification for fast mode (maximum clock frequency is 400 kHz). Information about the I<sup>2</sup>C-bus can be found in the brochure "The I<sup>2</sup>C-bus and how to use it" (order number 9398 393 40011).
- [29] The SDA and SCL lines will not be pulled down if V<sub>P</sub> is switched off.
- [30] The threshold is dependent on V<sub>P</sub>.
- [31] The threshold is independent of V<sub>P</sub>.

**Table 56. Examples to the FM PLL filter**

B <sub>LF(-3dB)</sub> (kHz)	C <sub>s</sub> (nF)	C <sub>par</sub> (pF)	R <sub>s</sub> (kΩ)	Comment
210	2.2	100	8.2	recommended for single-carrier-sound, FM narrow
410	2.2	47	5.6	recommended for single-carrier-sound, FM wide
130	2.2	470	5.6	recommended for two-carrier-sound, FM narrow
210	2.2	47	8.2	used for test circuit

**Table 57. Input frequencies and carrier ratios (examples)**

Symbol	Parameter	B/G standard	M/N standard	L standard	L-accent standard	Unit
f <sub>PC</sub>	picture carrier frequency	38.375	38.375	38.375	33.625	MHz
f <sub>SC1</sub>	sound carrier frequency 1	32.825	33.825	31.825	40.125	MHz
f <sub>SC2</sub>	sound carrier frequency 2	32.583	-	-	-	MHz
PC / SC1	picture to first sound carrier ratio	13	7	10	10	dB
PC / SC2	picture to second sound carrier ratio	20	-	-	-	dB

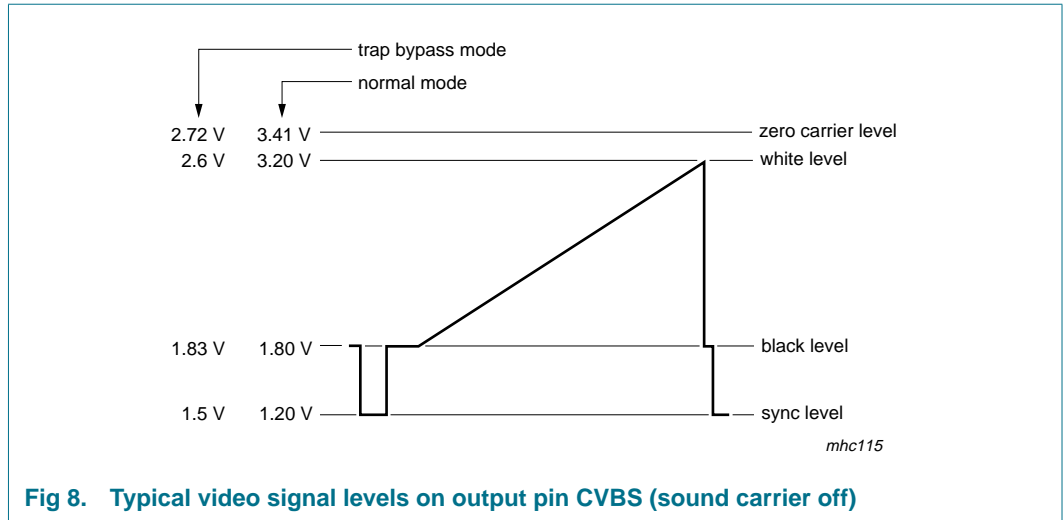

Fig 8. Typical video signal levels on output pin CVBS (sound carrier off)

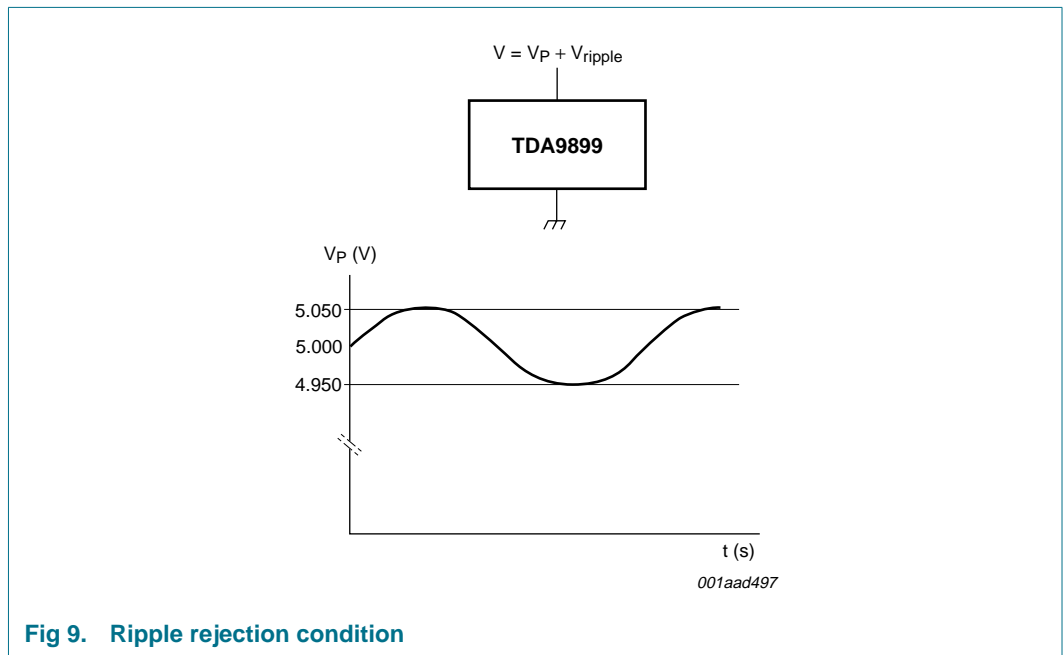
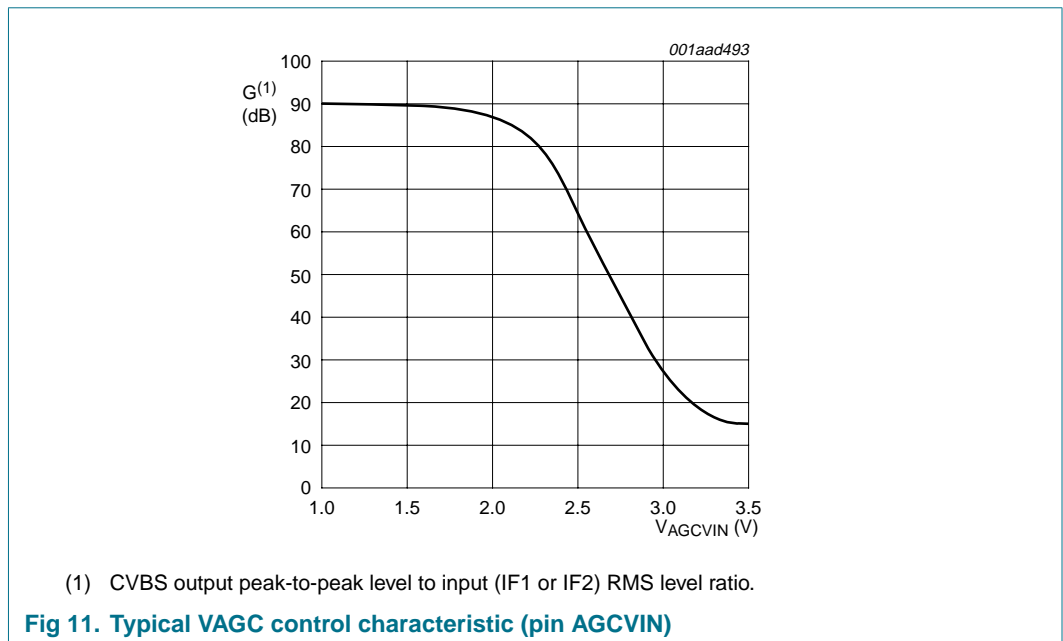
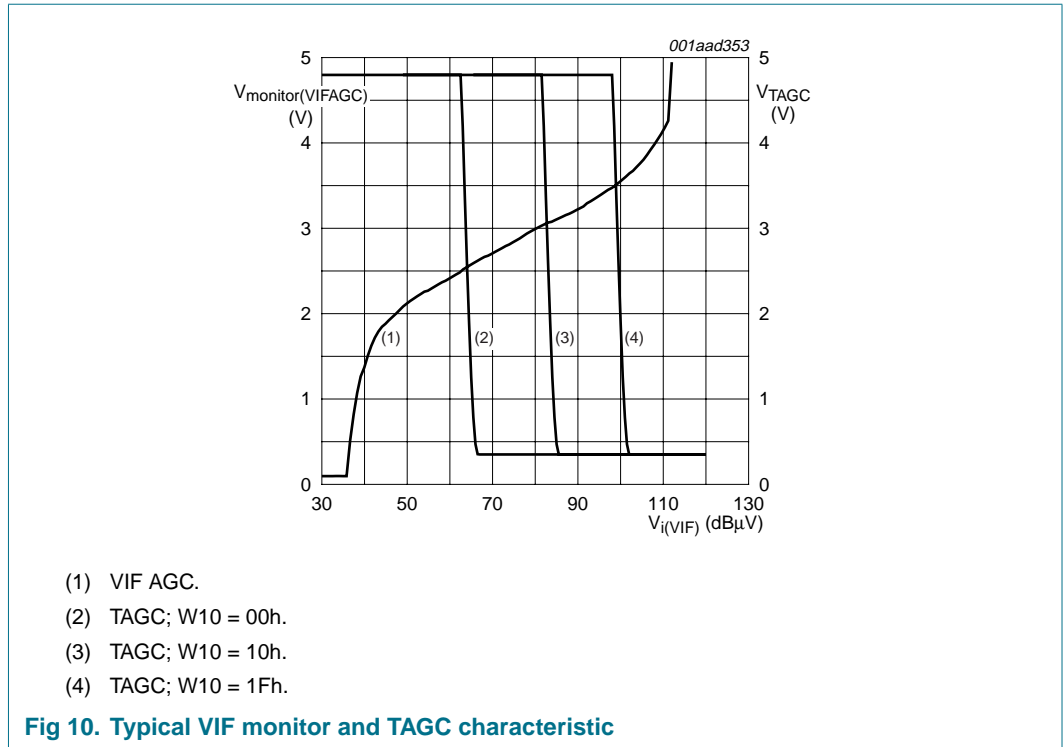
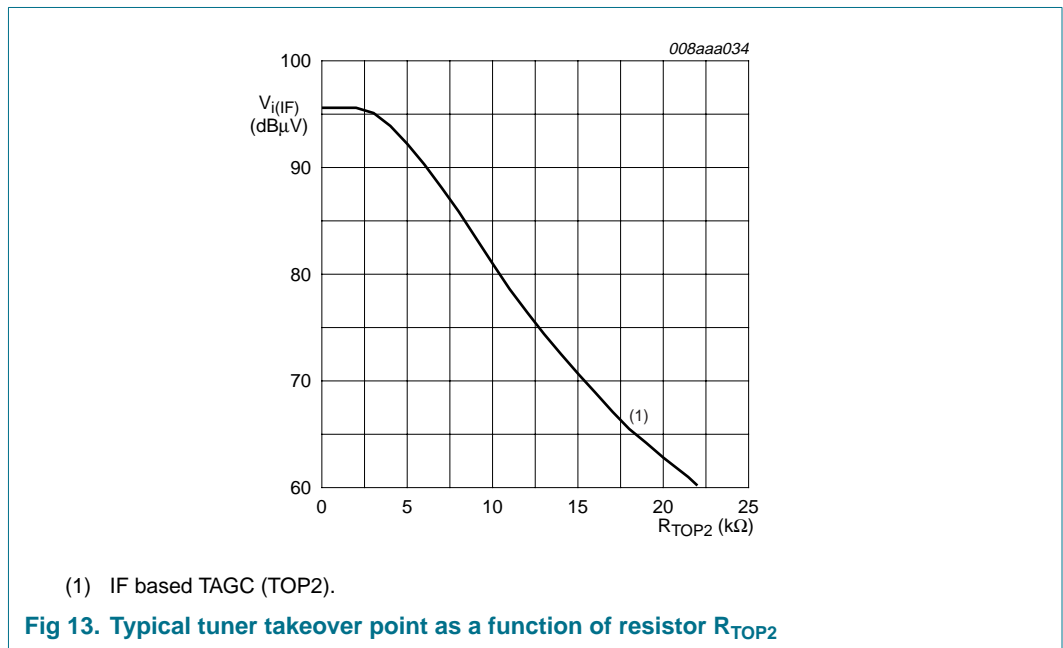
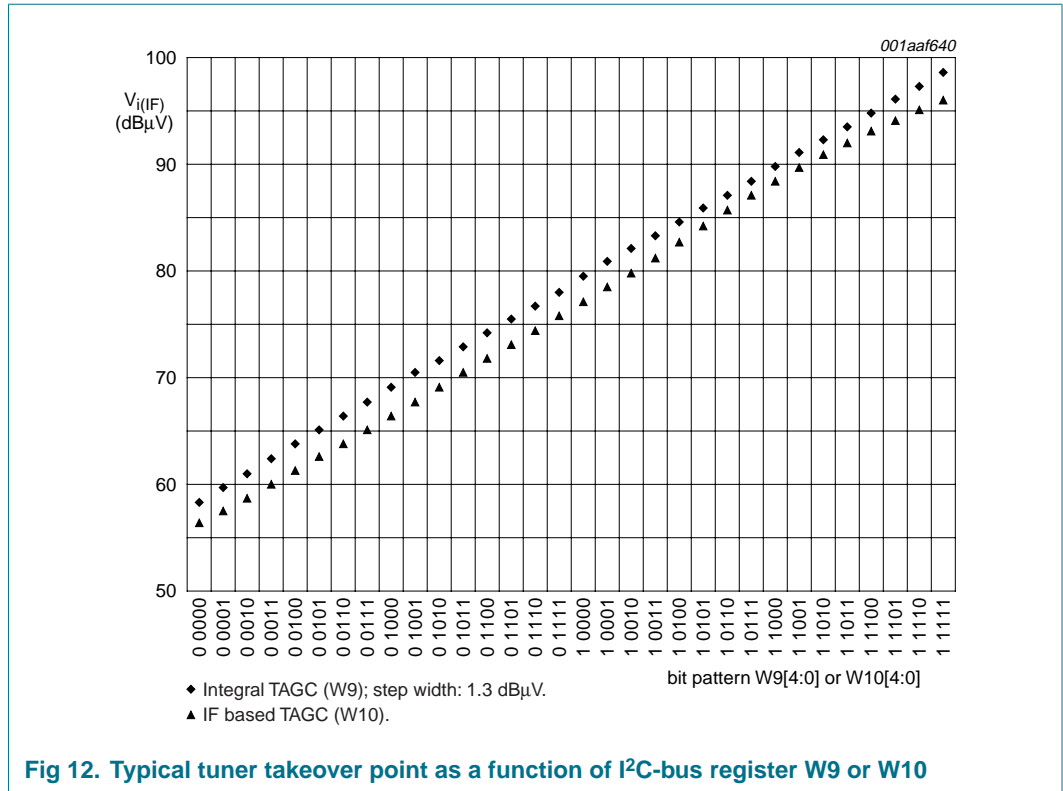
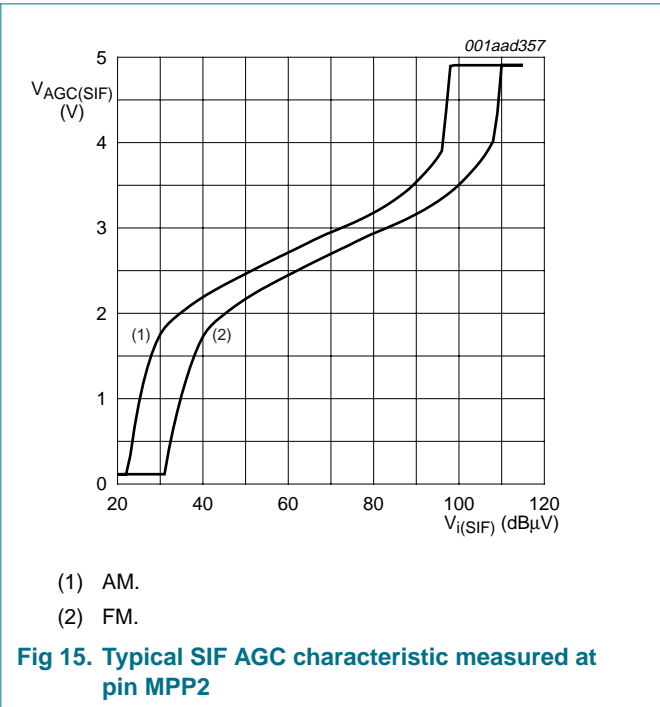
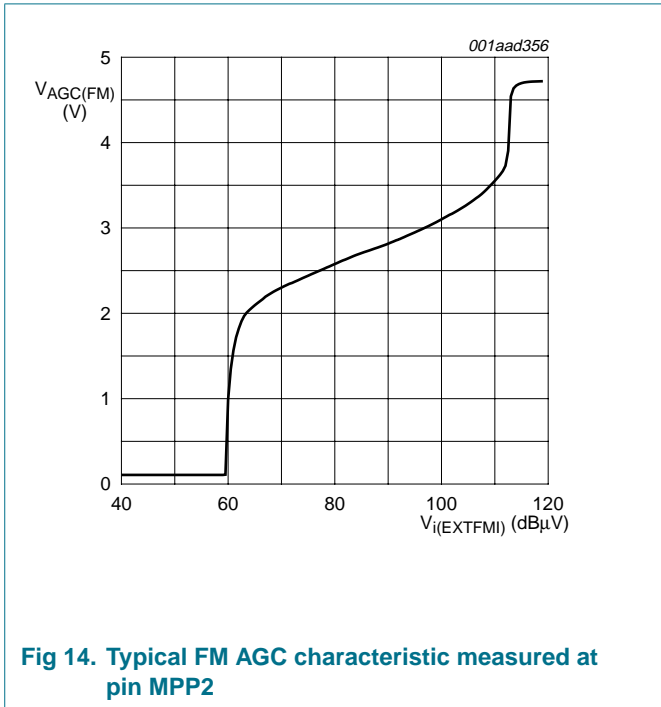

Fig 9. Ripple rejection condition









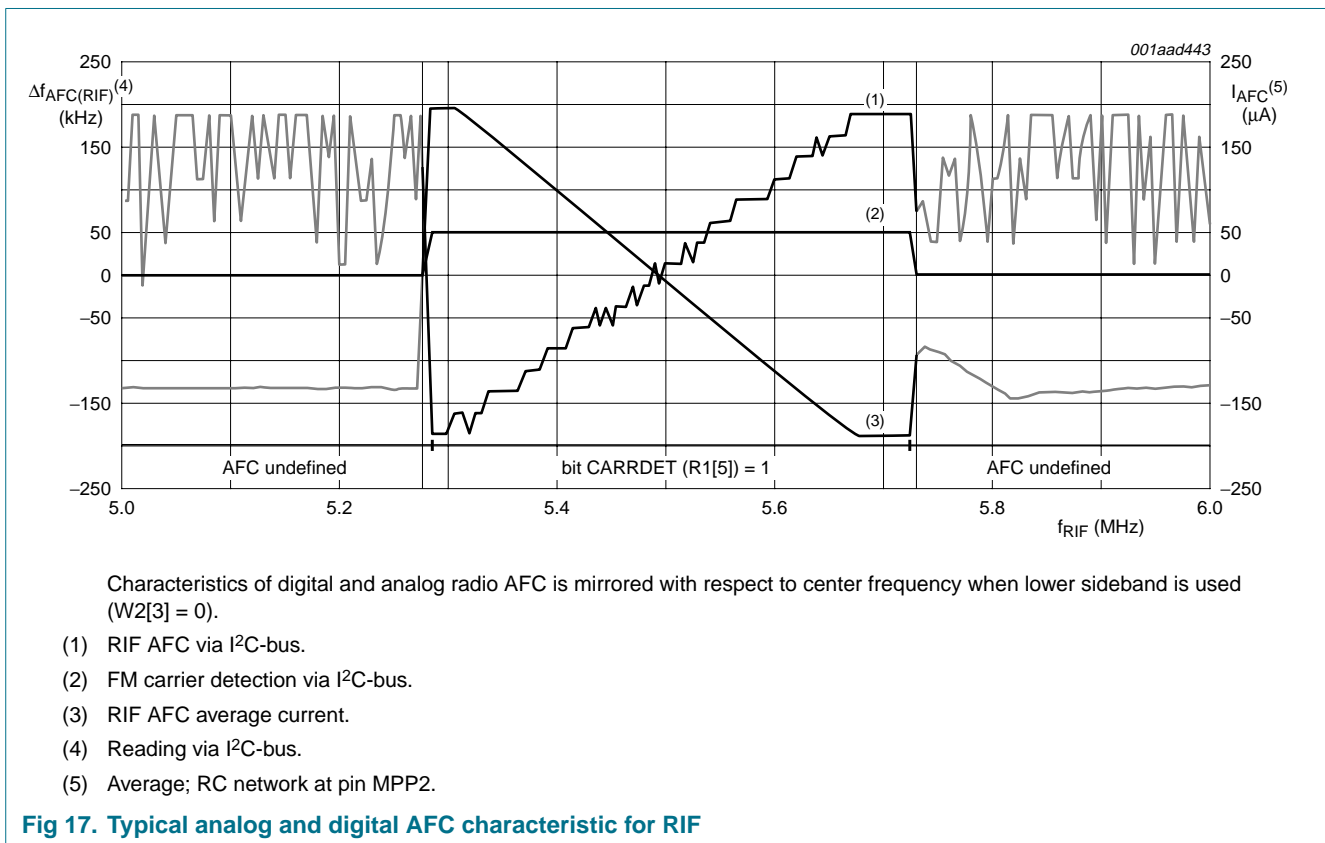
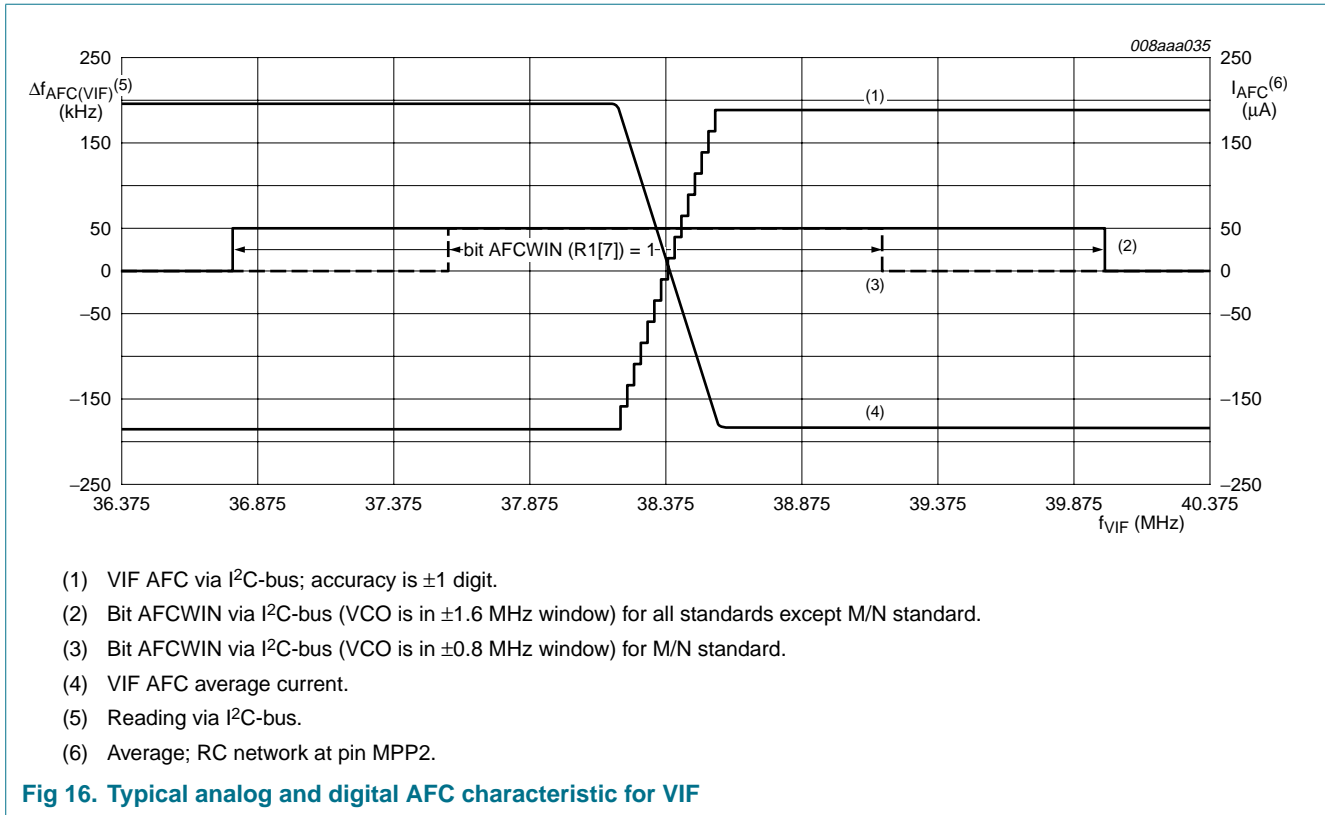

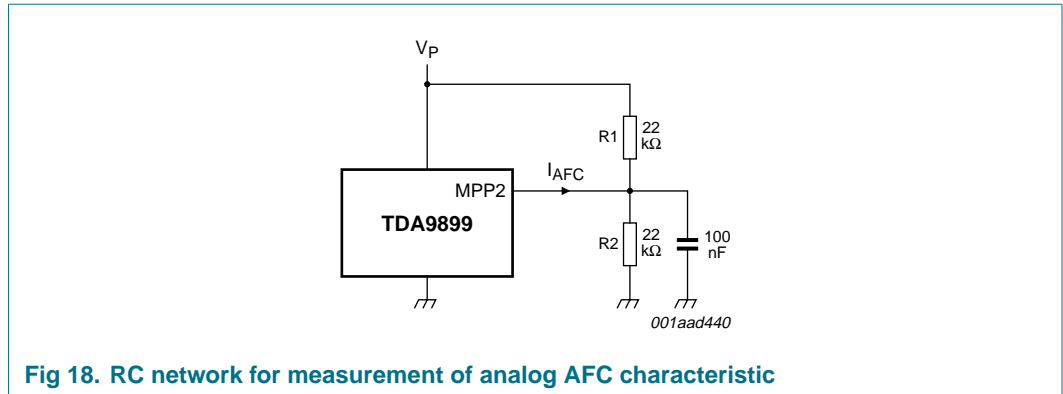
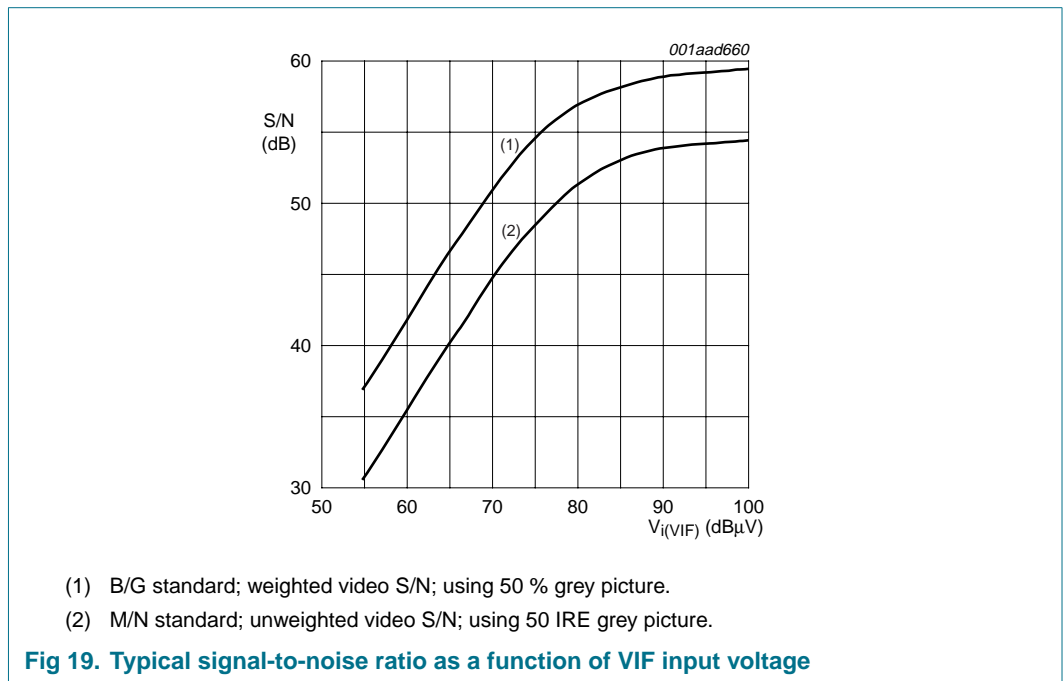
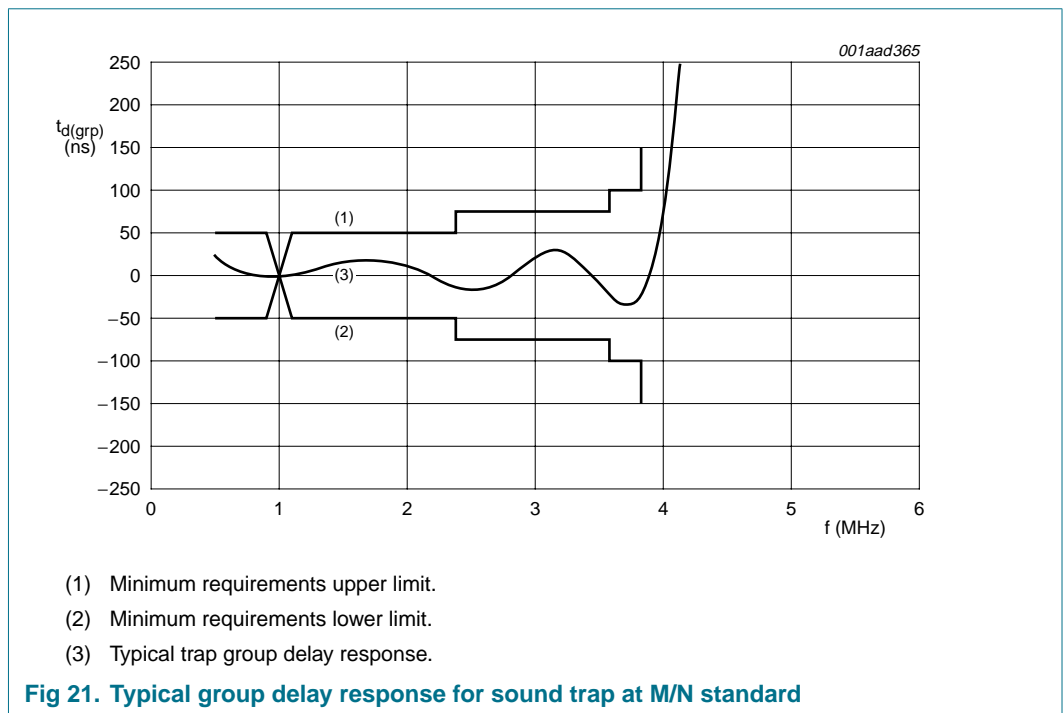
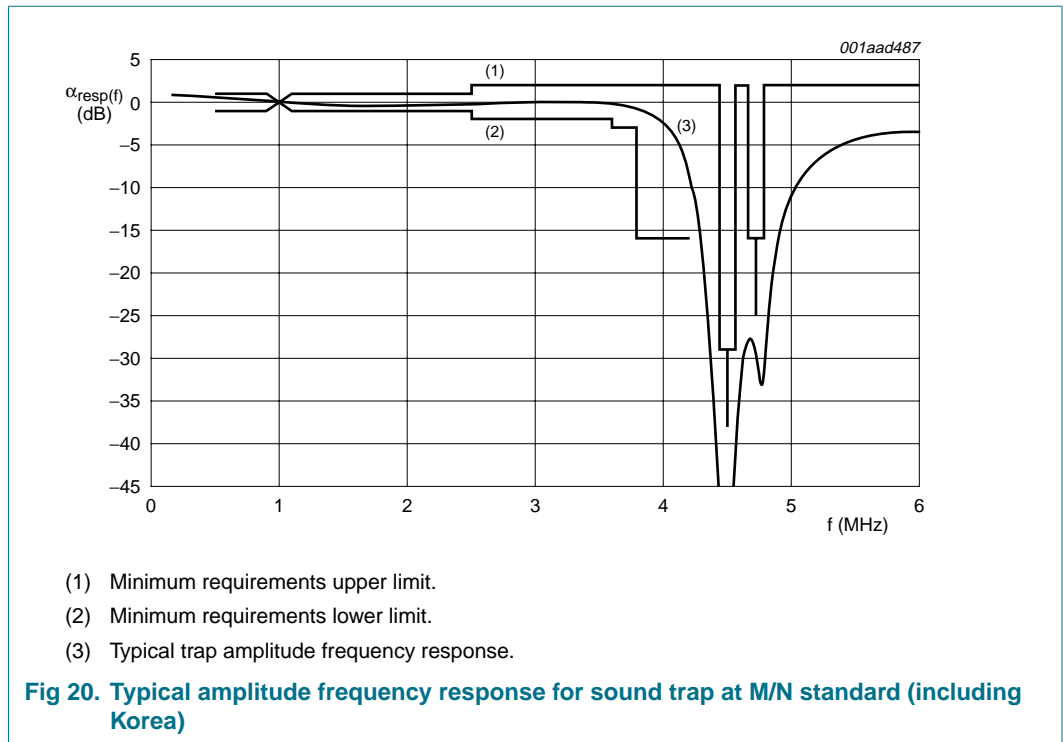

Fig 18. RC network for measurement of analog AFC characteristic



- (1) B/G standard; weighted video S/N; using 50 % grey picture.
- (2) M/N standard; unweighted video S/N; using 50 IRE grey picture.

Fig 19. Typical signal-to-noise ratio as a function of VIF input voltage



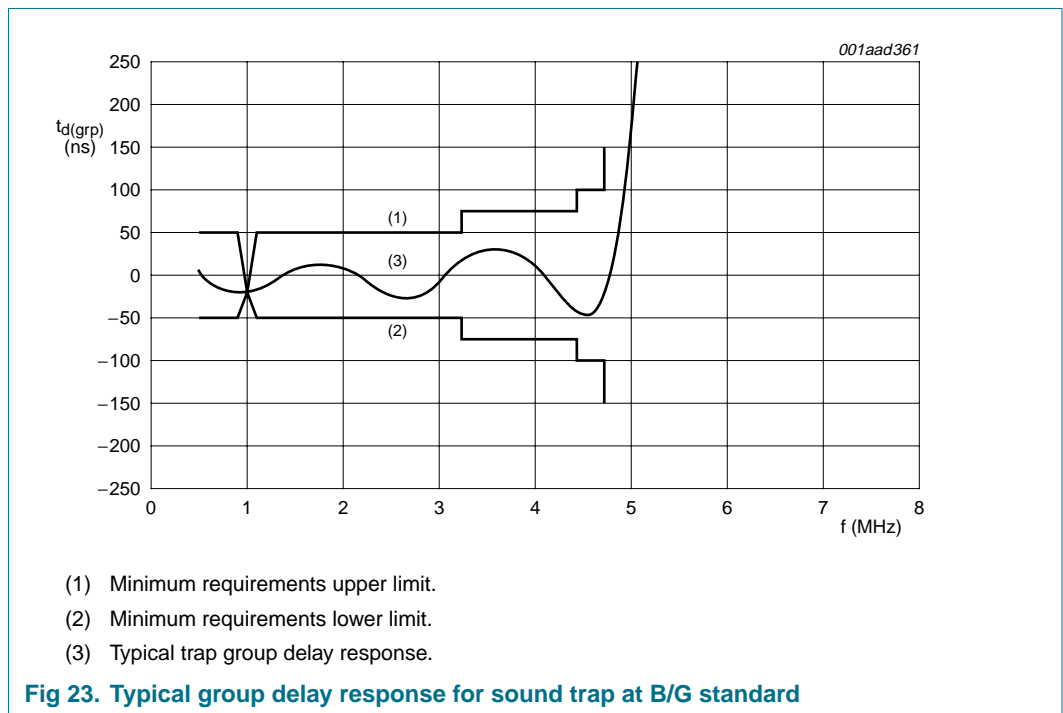
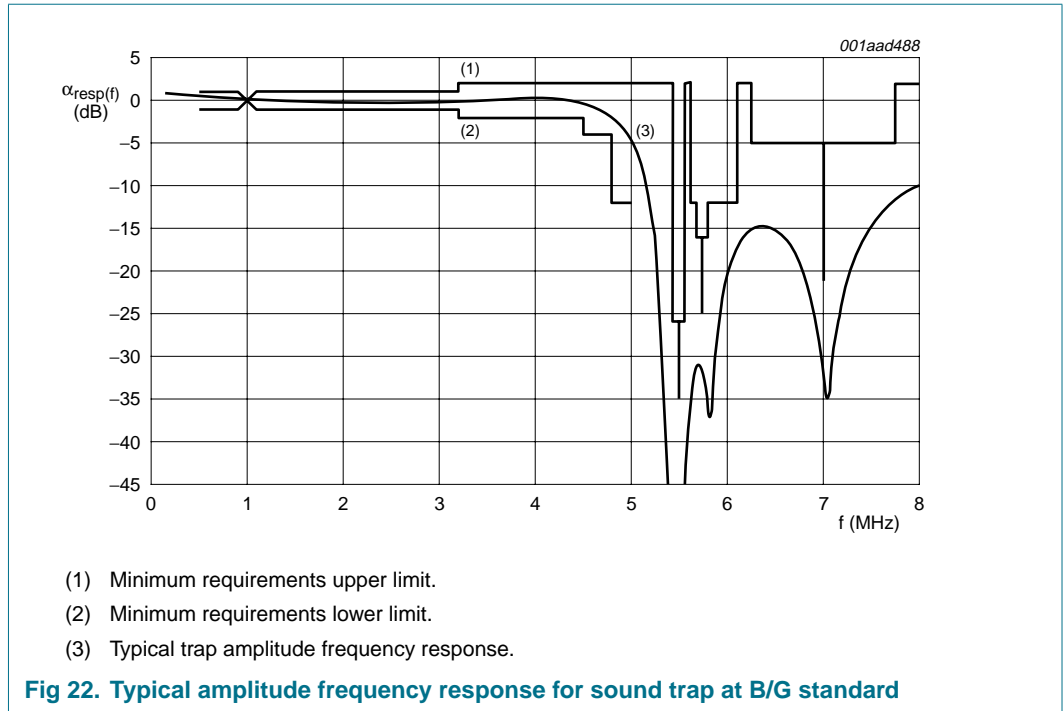

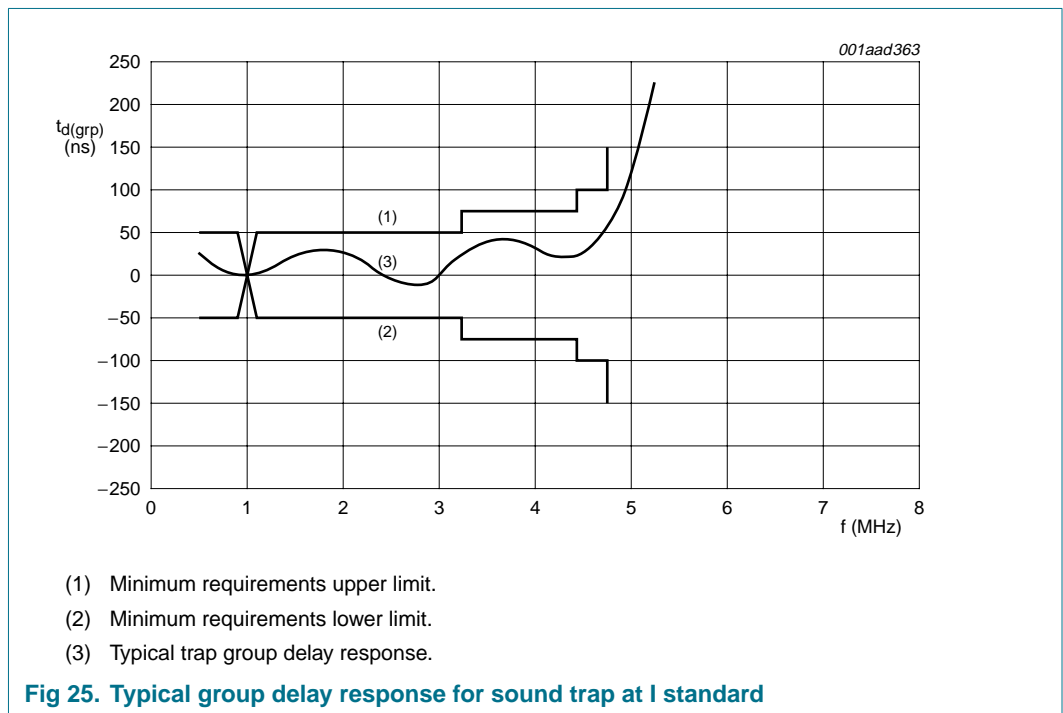
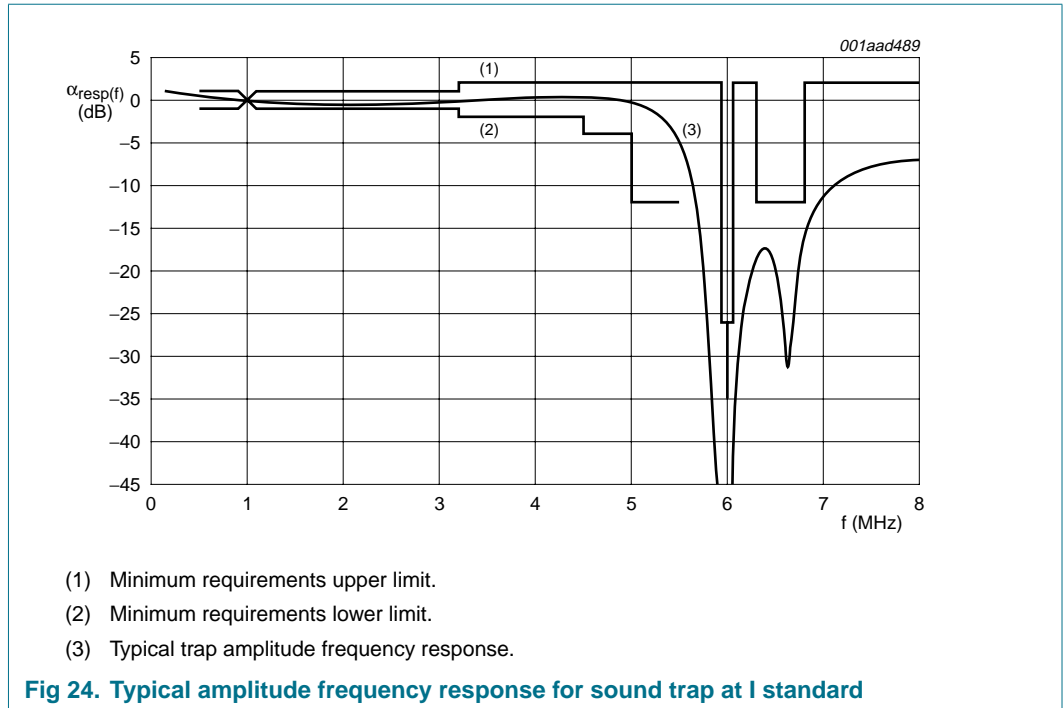

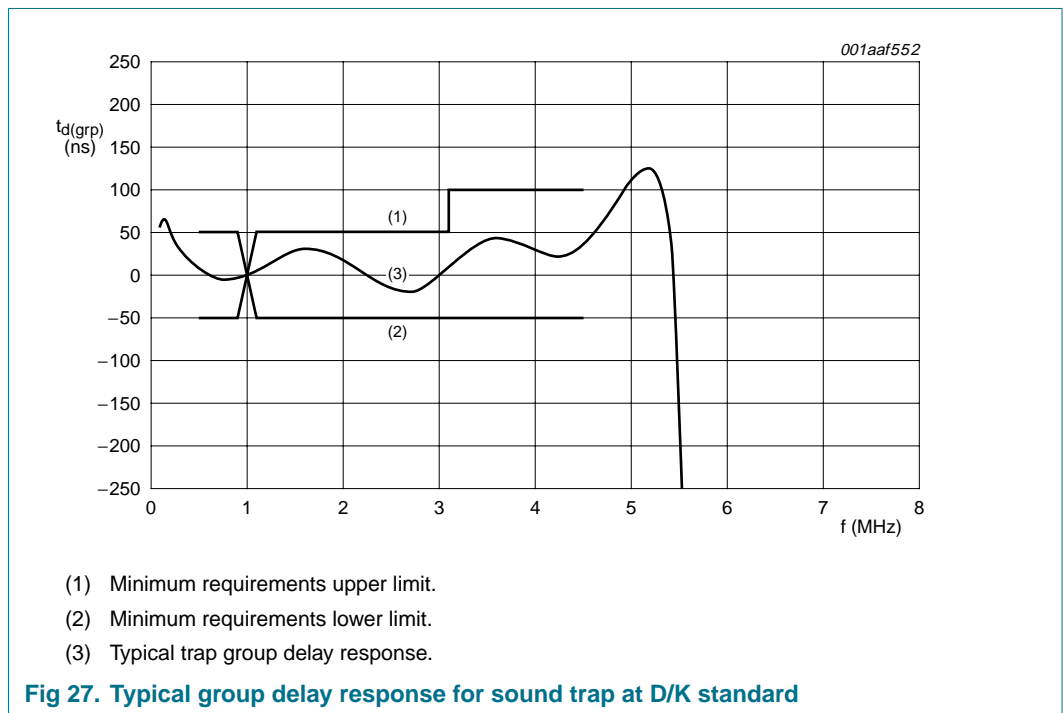
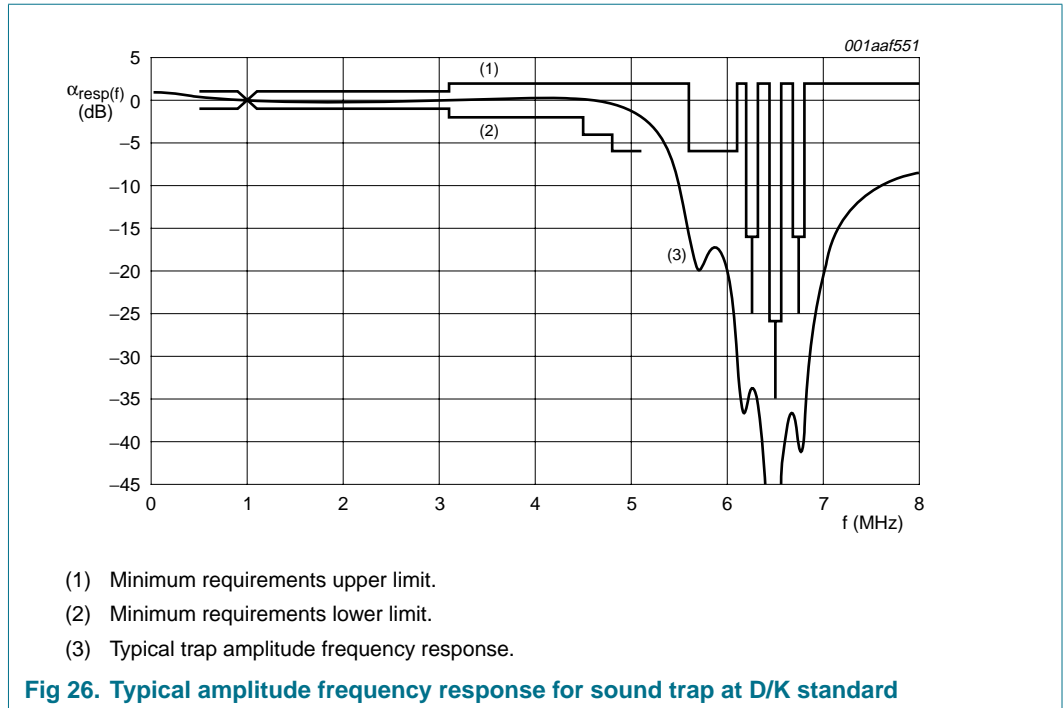



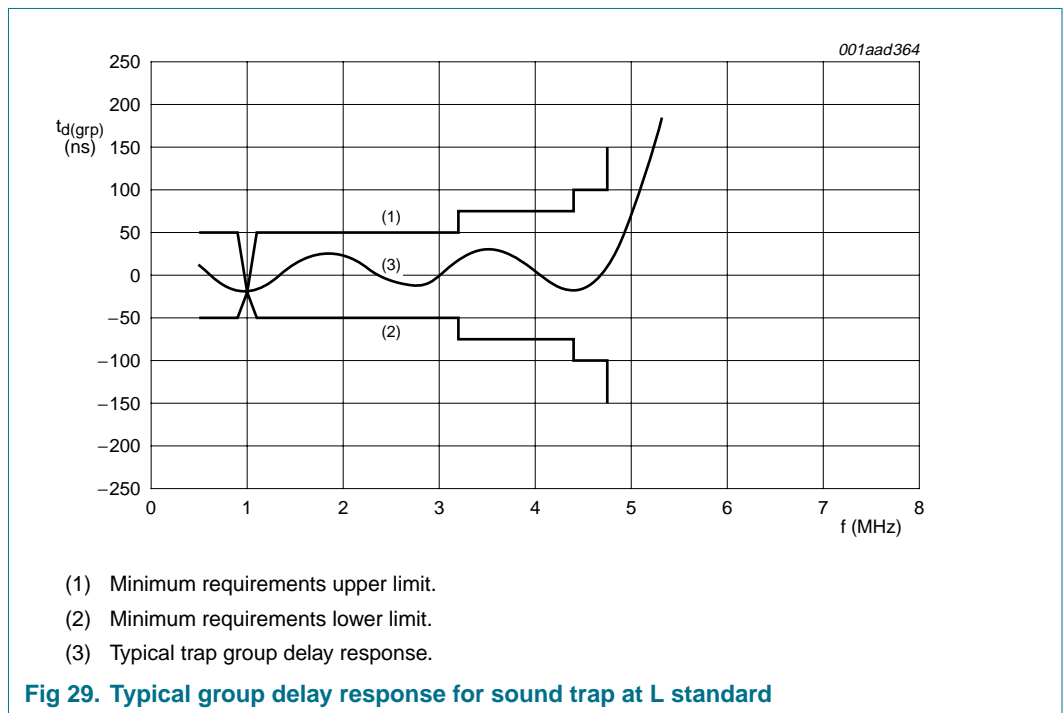
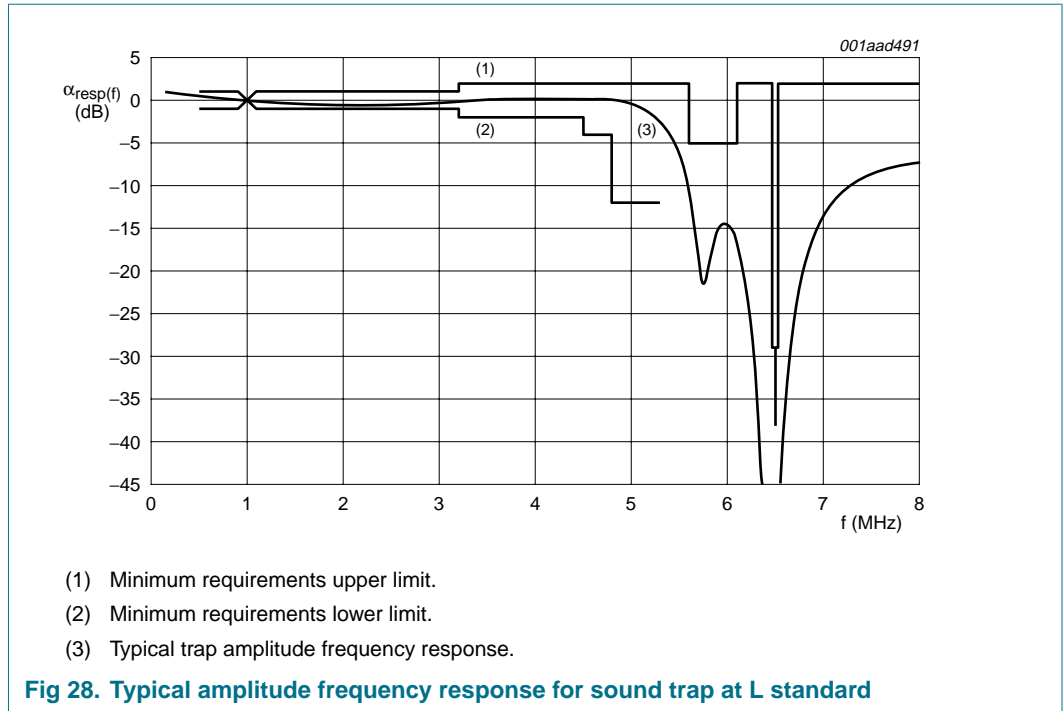

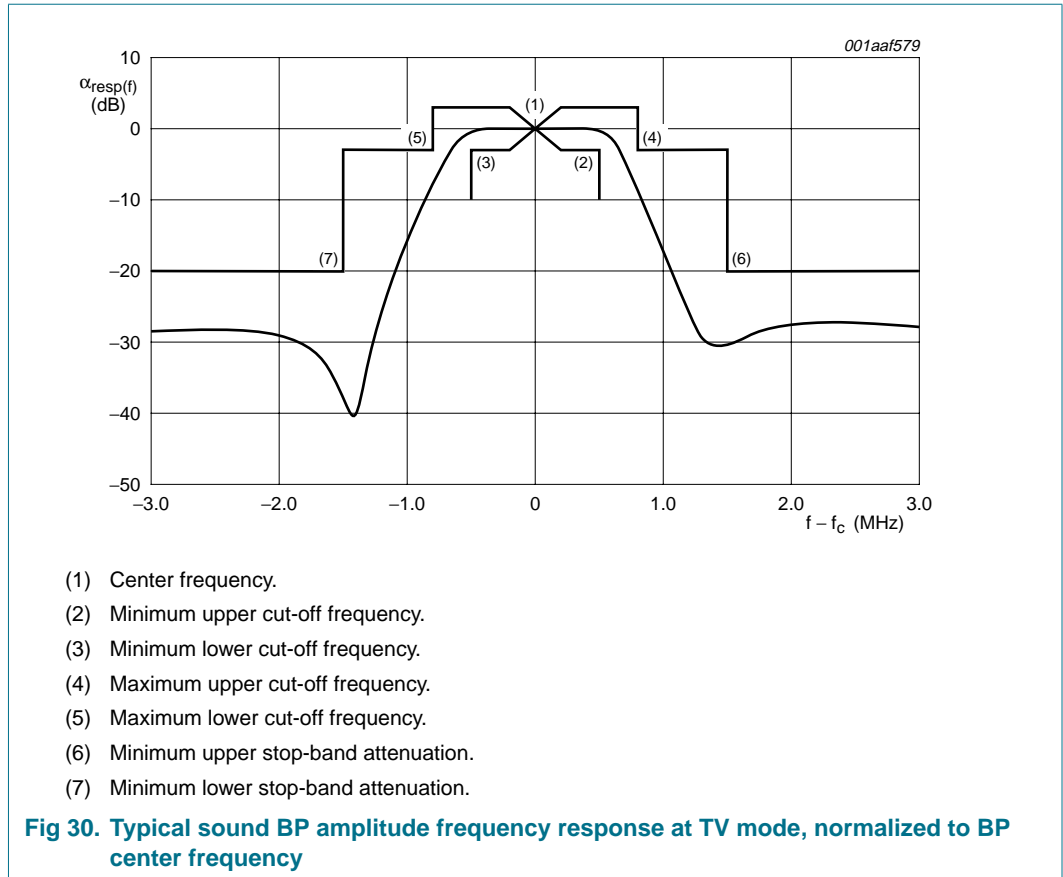

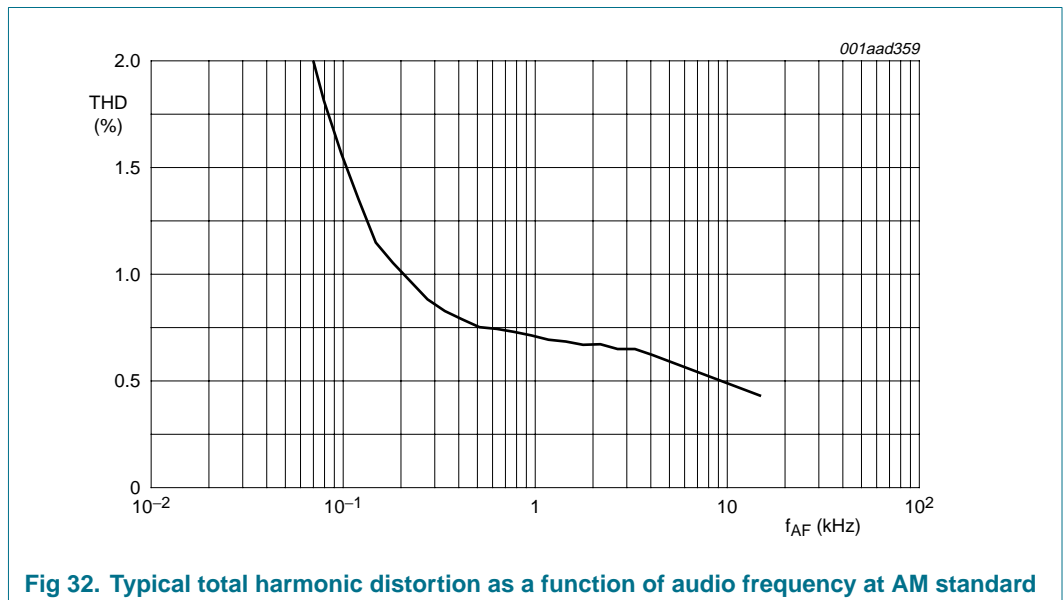
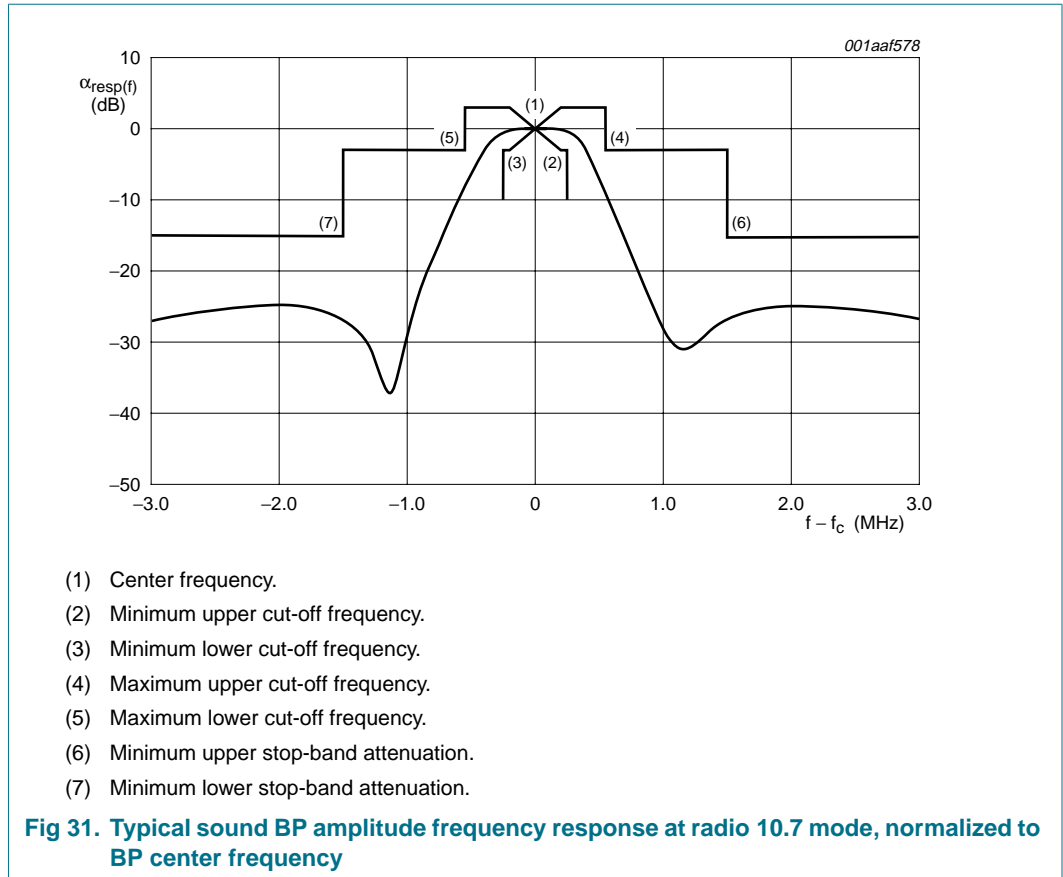

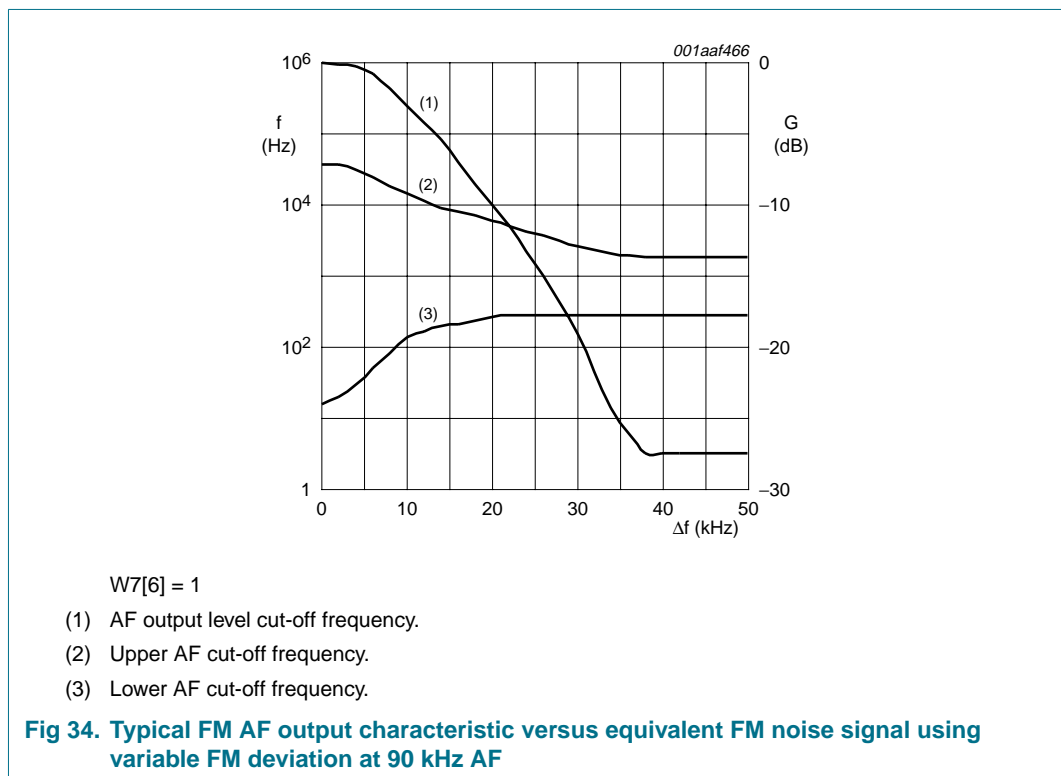
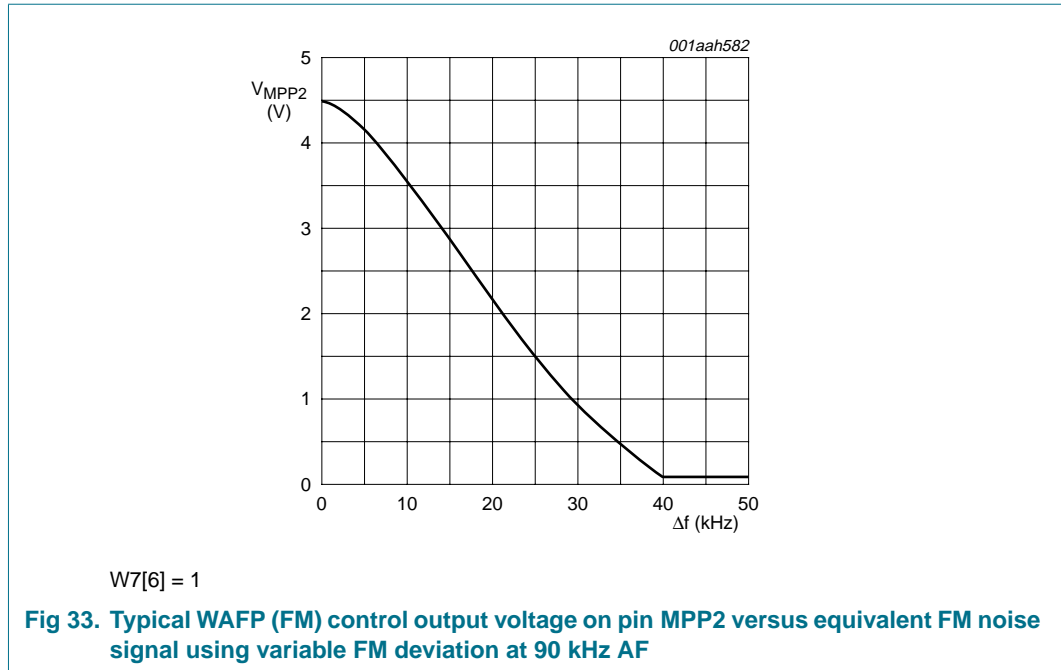

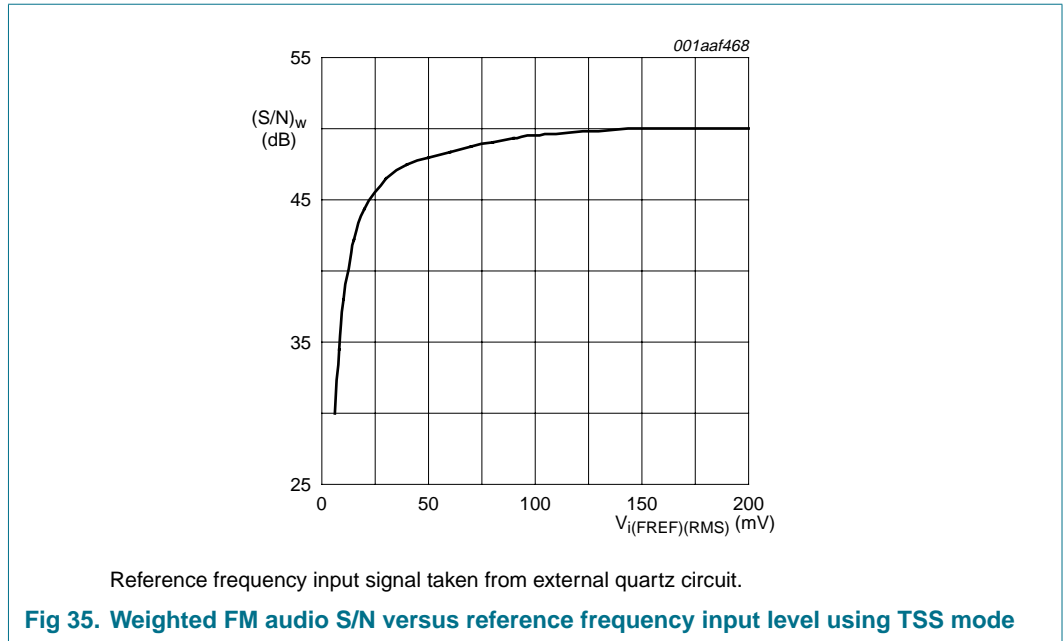

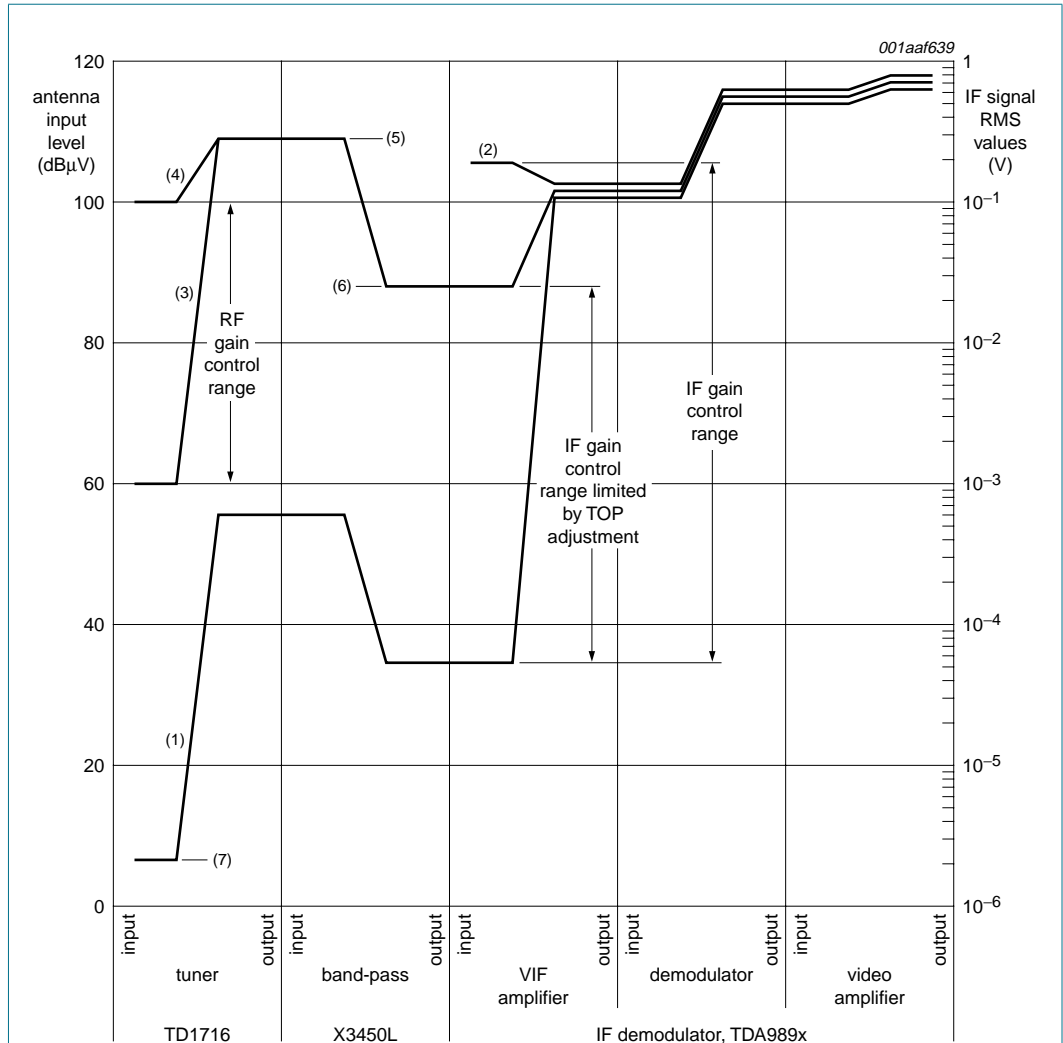

Video signal related peak-to-peak levels are divided by factor  $2\sqrt{2}$  in order to conform with the RMS value scale of the secondary y-axis, but disregarding the none sine wave signal content.

- (1) Signal levels for -1 dB video output level using maximum RF gain and maximum IF gain.
- (2) Signal levels for +1 dB video output level using minimum IF gain.
- (3) Signal levels for TOP-adjusted tuner output level using maximum RF gain and adjustment-related minimum IF gain.
- (4) Signal levels for TOP-adjusted tuner output level using minimum RF gain and adjustment-related minimum IF gain.
- (5) TOP-adjusted tuner output level.
- (6) TOP-adjusted VIF amplifier input level.
- (7) Minimum antenna input level at -1 dB video level.

Fig 36. Front-end level diagram

## 12.2 Digital TV signal processing

**Table 58. Characteristics**

$V_P = 5\text{ V}$ <sup>[1]</sup>;  $T_{amb} = 25\text{ °C}$ ; 8 MHz system; see [Table 36](#) and [Table 37](#); CW test input signal is used for specification;  $V_{i(IF)} = 10\text{ mV (RMS)}$ ;  $f_{IF} = 36\text{ MHz}$  for low IF output of 5 MHz; IF input from 50 Ω via broadband transformer 1 : 1; gain controlled amplifier adjusted to typical specified output level; measurements taken in test circuit of [Figure 49](#) with 4 MHz crystal oscillator reference; unless otherwise specified.

Symbol	Parameter	Conditions	Min	Typ	Max	Unit
<b>IF amplifier; pins IF3A and IF3B or IF1A and IF1B or IF2A and IF2B</b>						
$V_I$	input voltage		1.8	1.93	2.2	V
$R_{i(dif)}$	differential input resistance		[2] -	2	-	kΩ
$C_{i(dif)}$	differential input capacitance		[2] -	3	-	pF
$G_{IF(cr)}$	control range IF gain		[2] 60	66	-	dB
<b>DTV differential output; pins OUT1A, OUT1B, OUT2A and OUT2B</b>						
$V_O$	output voltage	pin open-circuit	1.8	2.0	2.2	V
$I_{bias(int)}$	internal bias current (DC)	for emitter-follower	2.0	2.5	-	mA
$I_{sink(o)(max)}$	maximum output sink current	DC and AC; see <a href="#">Figure 37</a>	[3] 1.4	1.7	-	mA
$I_{source(o)(max)}$	maximum output source current	DC and AC; see <a href="#">Figure 37</a>	[3] 6.0	-	-	mA
$R_O$	output resistance	differential; output active	[2] -	-	50	Ω
		output inactive; internal resistance to GND	[2] -	800	-	Ω
$V_{i(IF)(RMS)}$	RMS IF input voltage	minimum input sine wave level for nominal output level	-	70	100	μV
		maximum input sine wave level for nominal output level	130	170	-	mV
		permissible overload	[2] -	-	320	mV
<b>Direct IF; pins OUT2A and OUT2B</b>						
$G_{IF(max)}$	maximum IF gain	output peak-to-peak level to input RMS level ratio	[2] -	83	-	dB
$V_{o(dif)(p-p)}$	peak-to-peak differential output voltage	between pin OUT2A and pin OUT2B	[4]			
		W4[7] = 0	-	1.0	1.1	V
		W4[7] = 1	-	0.50	0.55	V
C/N	carrier-to-noise ratio	at $f_o = 33.4\text{ MHz}$ ; see <a href="#">Figure 38</a>	[2][5][6]			
		$V_{i(IF)} = 10\text{ mV (RMS)}$	115	124	-	dBc/Hz
		$V_{i(IF)} = 0.5\text{ mV (RMS)}$	90	104	-	dBc/Hz
$\alpha_{IM}$	intermodulation suppression	input signals: $f_i = 47.0\text{ MHz}$ and $57.5\text{ MHz}$ ; output signals: $f_o = 36.5\text{ MHz}$ or $68.0\text{ MHz}$ ; see <a href="#">Figure 39</a>	[2]			
		W4[7] = 0	40	-	-	dB
		W4[7] = 1	40	-	-	dB

**Table 58. Characteristics ...continued**

$V_P = 5$  V<sup>[1]</sup>;  $T_{amb} = 25$  °C; 8 MHz system; see [Table 36](#) and [Table 37](#); CW test input signal is used for specification;  $V_{i(IF)} = 10$  mV (RMS);  $f_{IF} = 36$  MHz for low IF output of 5 MHz; IF input from 50 Ω via broadband transformer 1 : 1; gain controlled amplifier adjusted to typical specified output level; measurements taken in test circuit of [Figure 49](#) with 4 MHz crystal oscillator reference; unless otherwise specified.

Symbol	Parameter	Conditions	Min	Typ	Max	Unit
$f_{IF(-1dB)}$	lower -1 dB IF cut-off frequency		[2] -	7	-	MHz
$f_{-3dB(IF)u}$	upper IF cut-off frequency	W4[7] = 0	[4] 60	-	-	MHz
		W4[7] = 1	[7] 60	-	-	MHz
PSRR	power supply ripple rejection	residual spurious at nominal differential output voltage dependent on power supply ripple	[2]			
		$f_{ripple} = 70$ Hz	-	60	-	dB
		$f_{ripple} = 20$ kHz	-	60	-	dB

**Low or zero IF output signal; pins OUT1A and OUT1B or pins OUT2A and OUT2B; differential**

$G_{IF(max)}$	maximum IF gain	output peak-to-peak level to input RMS level ratio	[2] -	89	-	dB
$f_{synth}$	synthesizer frequency	see <a href="#">Table 37</a> and <a href="#">Table 38</a>	-	-	-	MHz
$V_{o(dif)(p-p)}$	peak-to-peak differential output voltage	W4[7] = 0	[4] -	2	-	V
		W4[7] = 1	[4] -	1	-	V
PSRR	power supply ripple rejection	residual spurious at nominal differential output voltage dependent on power supply ripple	[2]			
		$f_{ripple} = 70$ Hz	-	50	-	dB
		$f_{ripple} = 20$ kHz	-	30	-	dB

**Low IF output signal; pins OUT1A and OUT1B**

$\alpha_{ripple(pb)LIF}$	low IF pass-band ripple	6 MHz bandwidth	-	-	2.7	dB
		7 MHz bandwidth	-	-	2.7	dB
		8 MHz bandwidth	-	-	2.7	dB
$B_{-3dB}$	-3 dB bandwidth	BP off	[4] 11	15	-	MHz
		6 MHz bandwidth	[4] -	7.8	-	MHz
		7 MHz bandwidth	[4] -	8.8	-	MHz
		8 MHz bandwidth	[4] -	9.8	-	MHz
$\alpha_{stpb}$	stop-band attenuation	6 MHz band; $f = 11.75$ MHz	30	40	-	dB
		6 MHz band; $f = 20$ MHz	28	35	-	dB
		7 MHz band; $f = 13.75$ MHz	30	40	-	dB
		7 MHz band; $f = 20$ MHz	28	35	-	dB
		8 MHz band; $f = 15.75$ MHz	30	40	-	dB
		8 MHz band; $f = 20$ MHz	28	35	-	dB



**Table 58. Characteristics ...continued**

$V_P = 5\text{ V}$ ;  $T_{amb} = 25\text{ °C}$ ; 8 MHz system; see [Table 36](#) and [Table 37](#); CW test input signal is used for specification;  $V_{i(IF)} = 10\text{ mV (RMS)}$ ;  $f_{IF} = 36\text{ MHz}$  for low IF output of 5 MHz; IF input from  $50\text{ }\Omega$  via broadband transformer 1 : 1; gain controlled amplifier adjusted to typical specified output level; measurements taken in test circuit of [Figure 49](#) with 4 MHz crystal oscillator reference; unless otherwise specified.

Symbol	Parameter	Conditions	Min	Typ	Max	Unit
$\Delta t_{d(grp)}$	group delay time variation	from 1 MHz to 2 MHz	[2] -	90	200	ns
		from 2 MHz to end of band with a bandwidth of	[2]			
		6 MHz	-	90	160	ns
		7 MHz	-	90	160	ns
$\alpha_{image}$	image rejection	-10 MHz to 0 MHz				
		BP on	30	34	-	dB
		BP off	24	28	-	dB
C/N	carrier-to-noise ratio	at $f_o = 4.9\text{ MHz}$ ; see <a href="#">Figure 38</a>	[2][5][6]			
		$V_{i(IF)} = 10\text{ mV (RMS)}$	112	118	-	dBc/Hz
		$V_{i(IF)} = 0.5\text{ mV (RMS)}$	90	104	-	dBc/Hz
$\alpha_{H(ib)}$	in-band harmonics suppression	low IF = multiple of 1.31 MHz; $f_i = f_{synth} + 1.31\text{ MHz}$ ; see <a href="#">Figure 42</a>	[2]			
		W4[7] = 0	40	-	-	dB
		W4[7] = 1	40	-	-	dB
$\alpha_{IM}$	intermodulation suppression	input signals: $f_i = f_{synth} + 4.7\text{ MHz}$ and $f_{synth} + 5.3\text{ MHz}$ ; output signals: $f_o = 4.1\text{ MHz}$ or $5.9\text{ MHz}$ ; see <a href="#">Figure 41</a>	[2]			
		W4[7] = 0	40	-	-	dB
		W4[7] = 1	40	-	-	dB
$\alpha_{sp(ib)}$	in-band spurious suppression	single-ended AC load; $R_L = 1\text{ k}\Omega$ ; $C_L = 5\text{ pF}$ ; 1 MHz to end of band; BP on	[2] 50	-	-	dB
$\alpha_{sp(ob)}$	out-band spurious suppression	single-ended AC load; $R_L = 1\text{ k}\Omega$ ; $C_L = 5\text{ pF}$ ; BP on	[2] 50	-	-	dB
<b>Zero IF output signal; pins OUT1A and OUT1B or pins OUT2A and OUT2B</b>						
$\alpha_{ripple(pb)ZIF}$	zero IF pass-band ripple	3.0 MHz bandwidth	-	-	1.8	dB
		3.5 MHz bandwidth	-	-	1.8	dB
		4.0 MHz bandwidth	-	-	1.8	dB
$B_{-3dB}$	-3 dB bandwidth	BP off	[4] 11	15	-	MHz
		3.0 MHz bandwidth	[4] -	3.7	-	MHz
		3.5 MHz bandwidth	[4] -	4.2	-	MHz
		4.0 MHz bandwidth	[4] -	4.7	-	MHz

**Table 58. Characteristics ...continued**

$V_P = 5$  V<sup>[1]</sup>;  $T_{amb} = 25$  °C; 8 MHz system; see [Table 36](#) and [Table 37](#); CW test input signal is used for specification;  $V_{i(IF)} = 10$  mV (RMS);  $f_{IF} = 36$  MHz for low IF output of 5 MHz; IF input from 50 Ω via broadband transformer 1 : 1; gain controlled amplifier adjusted to typical specified output level; measurements taken in test circuit of [Figure 49](#) with 4 MHz crystal oscillator reference; unless otherwise specified.

Symbol	Parameter	Conditions	Min	Typ	Max	Unit
$\alpha_{stpb}$	stop-band attenuation	3.0 MHz band; $f = 7.75$ MHz	30	40	-	dB
		3.5 MHz band; $f = 9.25$ MHz	30	40	-	dB
		4.0 MHz band; $f = 10.75$ MHz	30	40	-	dB
		any band; $f = 15$ MHz	28	35	-	dB
$\Delta t_{d(grp)}$	group delay time variation	from 0 MHz to end of band with a bandwidth of <a href="#">[2]</a>	-	-	-	-
		3.0 MHz	-	60	100	ns
		3.5 MHz	-	50	100	ns
		4.0 MHz	-	45	100	ns
C/N	carrier-to-noise ratio	at $f_o = 1.9$ MHz; see <a href="#">Figure 38</a> <a href="#">[2][5][6]</a>	-	-	-	-
		$V_{i(IF)} = 10$ mV (RMS)	112	121	-	dBc/Hz
		$V_{i(IF)} = 0.5$ mV (RMS)	87	101	-	dBc/Hz
$\alpha_{IM}$	intermodulation suppression	input signals: $f_i = f_{synth} + 1.7$ MHz and $f_{synth} + 2.3$ MHz; output signals: $f_o = 1.1$ MHz or 2.9 MHz; see <a href="#">Figure 40</a>	40	-	-	dB
$\alpha_{sp(ib)}$	in-band spurious suppression	0.437 MHz to end of band; BP on	<a href="#">[2][4]</a> 40	-	-	dB
$\alpha_{sp(ob)}$	out-band spurious suppression	BP on	<a href="#">[2][4]</a> 50	-	-	dB
$\Delta\phi$	phase difference	mismatch between I and Q channel	<a href="#">[2]</a> -	-	6	deg
$\Delta G$	gain mismatch	mismatch between I and Q channel	-	-	2	dB
<b>IF AGC control; pin AGCDIN</b>						
$I_{sink(i)(max)}$	maximum input sink current		<a href="#">[2]</a> -	-	2	μA
$V_{i(max)}$	maximum input voltage		<a href="#">[2]</a> -	-	$V_P$	V
$V_{AGCDIN}$	voltage on pin AGCDIN		<a href="#">[2]</a> 0	-	3	V
$\Delta G_{IF}/\Delta V_{AGCDIN}$	change of IF gain with voltage on pin AGCDIN	$V_{AGCDIN} = 0.8$ V to 2.2 V	-	-45	-	dB/V

**Table 58. Characteristics ...continued**

$V_P = 5\text{ V}$ ;  $T_{amb} = 25\text{ }^\circ\text{C}$ ; 8 MHz system; see [Table 36](#) and [Table 37](#); CW test input signal is used for specification;  $V_{i(IF)} = 10\text{ mV (RMS)}$ ;  $f_{IF} = 36\text{ MHz}$  for low IF output of 5 MHz; IF input from  $50\text{ }\Omega$  via broadband transformer 1 : 1; gain controlled amplifier adjusted to typical specified output level; measurements taken in test circuit of [Figure 49](#) with 4 MHz crystal oscillator reference; unless otherwise specified.

Symbol	Parameter	Conditions	Min	Typ	Max	Unit
<b>Tuner AGC; pin TAGC</b>						
Integral TAGC loop mode (W6[7:6] = 10); TAGC is current output; unmodulated IF						
$V_{i(IF)(RMS)}$	RMS IF input voltage	at starting point of tuner AGC takeover;				
		$I_{sink(TAGC)} = 100\text{ }\mu\text{A}$				
		W9[4:0] = 0 0000	-	57.9	-	dB $\mu\text{V}$
		W9[4:0] = 1 0000	-	78.7	-	dB $\mu\text{V}$
		W9[4:0] = 1 1111	-	98.2	-	dB $\mu\text{V}$
$\alpha_{acc(set)TOP}$	TOP setting accuracy		-2	-	+2	dB
$I_{source}$	source current	TAGC charge current				
		normal mode	0.20	0.27	0.34	$\mu\text{A}$
		fast mode activated by internal level detector	7	10	13	$\mu\text{A}$
$I_{sink}$	sink current	TAGC discharge current; $V_{TAGC} = 1\text{ V}$	400	500	600	$\mu\text{A}$
$\Delta\alpha_{acc(set)TOP}/\Delta T$	TOP setting accuracy variation with temperature	$I_{sink(TAGC)} = 100\text{ }\mu\text{A}$ ; W9[4:0] = 1 0000	[2] -	-	0.02	dB/K
$R_L$	load resistance		[2] 50	-	-	M $\Omega$
$V_{sat(u)}$	upper saturation voltage	pin operating as current output	[2] $V_P - 0.3$	-	-	V
$V_{sat(l)}$	lower saturation voltage	pin operating as current output	[2] -	-	0.3	V
$\alpha_{th(fast)AGC}$	AGC fast mode threshold	activated by internal fast AGC detector; I <sup>2</sup> C-bus setting corresponds to W9[4:0] = 1 0000	[2] 6	8	10	dB
$t_d$	delay time	before activating; $V_{i(IF)}$ below $\alpha_{th(fast)AGC}$	[2] 40	60	80	ms
<b>Filter synthesizer PLL; pin LFSYN1</b>						
$V_{LFSYN1}$	voltage on pin LFSYN1		1.0	-	3.5	V
$K_O$	VCO steepness	$\Delta f_{VCO} / \Delta V_{LFSYN1}$	-	3.75	-	MHz/V
$K_D$	phase detector steepness	$\Delta I_{LFSYN1} / \Delta \phi_{VCO}$	-	9	-	$\mu\text{A}/\text{rad}$
$I_{sink(o)PD(max)}$	maximum phase detector output sink current		-	-	65	$\mu\text{A}$
$I_{source(o)PD(max)}$	maximum phase detector output source current		-	-	65	$\mu\text{A}$

**Table 58. Characteristics ...continued**

$V_P = 5$  V<sup>[1]</sup>;  $T_{amb} = 25$  °C; 8 MHz system; see [Table 36](#) and [Table 37](#); CW test input signal is used for specification;  $V_{i(IF)} = 10$  mV (RMS);  $f_{IF} = 36$  MHz for low IF output of 5 MHz; IF input from 50 Ω via broadband transformer 1 : 1; gain controlled amplifier adjusted to typical specified output level; measurements taken in test circuit of [Figure 49](#) with 4 MHz crystal oscillator reference; unless otherwise specified.

Symbol	Parameter	Conditions	Min	Typ	Max	Unit	
<b>Conversion synthesizer PLL; pin LFSYN2</b>							
$V_{LFSYN2}$	voltage on pin LFSYN2		1	-	3	V	
$K_O$	VCO steepness	$\Delta f_{VCO} / \Delta V_{LFSYN2}$	-	31	-	MHz/V	
$K_D$	phase detector steepness	$\Delta I_{LFSYN2} / \Delta \phi_{VCO}$ ; see <a href="#">Table 59</a> ; $f_{VCO}$ selection:					
		22 MHz to 29.5 MHz	-	32	-	μA/rad	
		30 MHz to 37.5 MHz	-	38	-	μA/rad	
		38 MHz to 45.5 MHz	-	47	-	μA/rad	
		46 MHz to 53.5 MHz	-	61	-	μA/rad	
		57 MHz	-	61	-	μA/rad	
$I_{o(PD)}$	phase detector output current	sink or source; $f_{VCO}$ selection:					
		22 MHz to 29.5 MHz	-	200	-	μA	
		30 MHz to 37.5 MHz	-	238	-	μA	
		38 MHz to 45.5 MHz	-	294	-	μA	
		46 MHz to 53.5 MHz	-	384	-	μA	
		57 MHz	-	384	-	μA	
$\Phi_{n(synth)}$	synthesizer phase noise	$f_{synth} = 31$ MHz; $f_{IF} = 36$ MHz					
		at 1 kHz	[2] 89	99	-	dBc/Hz	
		at 10 kHz	[2] 89	99	-	dBc/Hz	
		at 100 kHz	[2] 98	102	-	dBc/Hz	
		at 1.4 MHz	[2] 115	119	-	dBc/Hz	
		$f_{synth} = 40$ MHz; $f_{IF} = 44$ MHz; external 4 MHz reference signal of 265 mV (RMS) and phase noise better than 120 dBc/Hz; see <a href="#">Figure 47</a>					
		at 1 kHz	[2] 89	96	-	dBc/Hz	
		at 10 kHz	[2] 89	100	-	dBc/Hz	
		at 100 kHz	[2] 96	100	-	dBc/Hz	
		at 1.4 MHz	[2] 115	118	-	dBc/Hz	
$\alpha_{sp}$	spurious suppression	multiple of $\Delta f = 500$ kHz	[2] 50	-	-	dBc	
$I_L$	leakage current	synthesizer spurious performance > 50 dBc	[2] -	-	10	nA	

**Reference frequency**

**General**

$f_{ref}$	reference frequency		[8] -	4	-	MHz
-----------	---------------------	--	-------	---	---	-----

**Table 58. Characteristics ...continued**

$V_P = 5\text{ V}$ ;  $T_{amb} = 25\text{ }^\circ\text{C}$ ; 8 MHz system; see [Table 36](#) and [Table 37](#); CW test input signal is used for specification;  $V_{i(IF)} = 10\text{ mV (RMS)}$ ;  $f_{IF} = 36\text{ MHz}$  for low IF output of 5 MHz; IF input from  $50\text{ }\Omega$  via broadband transformer 1 : 1; gain controlled amplifier adjusted to typical specified output level; measurements taken in test circuit of [Figure 49](#) with 4 MHz crystal oscillator reference; unless otherwise specified.

Symbol	Parameter	Conditions	Min	Typ	Max	Unit
<b>Reference frequency generation with crystal; pin OPTXTAL</b>						
$V_{OPTXTAL}$	voltage on pin OPTXTAL (DC)	pin open-circuit	2.3	2.6	2.9	V
$R_i$	input resistance		[2] -	2	-	k $\Omega$
$R_{rsn(xtal)}$	crystal resonance resistance		-	-	200	$\Omega$
$C_{pull}$	pull capacitance		[9] -	-	-	pF
$R_{swoff(OPTXTAL)}$	switch-off resistance on pin OPTXTAL	to switch off crystal input by external resistor wired between pin OPTXTAL and GND	0.22	-	4.7	k $\Omega$
$I_{swoff}$	switch-off current	$R_{swoff(OPTXTAL)} = 0.22\text{ k}\Omega$	-	-	1600	$\mu\text{A}$
		$R_{swoff(OPTXTAL)} = 3.3\text{ k}\Omega$	-	500	-	$\mu\text{A}$
<b>Reference frequency input from external source; pin OPTXTAL</b>						
$V_{OPTXTAL}$	voltage on pin OPTXTAL (DC)	pin open-circuit	2.3	2.6	2.9	V
$R_i$	input resistance		[2] -	2	-	k $\Omega$
$V_{ref(RMS)}$	RMS reference voltage		80	-	400	mV
$R_O$	output resistance	of external reference signal source	[2] -	2	4.7	k $\Omega$
$C_{dec}$	decoupling capacitance	to external reference signal source	[2] 22	100	-	pF
<b>Reference frequency input from external source; W7[7] = 0; pin FREF</b>						
$V_{FREF}$	voltage on pin FREF (DC)	pin open-circuit	2.2	2.5	2.8	V
$R_i$	input resistance		[2] 50	-	-	k $\Omega$
$f_{ref}$	reference frequency		[8] -	4	-	MHz
$V_{ref(RMS)}$	RMS reference voltage	see <a href="#">Figure 47</a>	15	150	500	mV
$R_O$	output resistance	of external reference signal source; AC-coupled	-	-	4.7	k $\Omega$
$C_{dec}$	decoupling capacitance	to external reference signal source	22	100	-	pF
$R_{swoff(FREF)}$	switch-off resistance on pin FREF	to switch off reference signal input by external resistor wired between pin FREF and GND	3.9	-	27	k $\Omega$
$I_{swoff}$	switch-off current	$R_{swoff(FREF)} = 3.9\text{ k}\Omega$	-	-	100	$\mu\text{A}$
		$R_{swoff(FREF)} = 22\text{ k}\Omega$	-	75	-	$\mu\text{A}$

**Table 58. Characteristics ...continued**

$V_P = 5\text{ V}$ <sup>[1]</sup>;  $T_{amb} = 25\text{ °C}$ ; 8 MHz system; see [Table 36](#) and [Table 37](#); CW test input signal is used for specification;  $V_{i(IF)} = 10\text{ mV (RMS)}$ ;  $f_{IF} = 36\text{ MHz}$  for low IF output of 5 MHz; IF input from 50 Ω via broadband transformer 1 : 1; gain controlled amplifier adjusted to typical specified output level; measurements taken in test circuit of [Figure 49](#) with 4 MHz crystal oscillator reference; unless otherwise specified.

Symbol	Parameter	Conditions	Min	Typ	Max	Unit
Reference frequency output; W7[7] = 1; pin FREF						
$V_{FREF}$	voltage on pin FREF (DC)	pin open-circuit	2.3	2.6	2.9	V
$R_O$	output resistance		[2] 200	350	500	Ω
$V_{o(fref)(p-p)}$	peak-to-peak reference frequency output voltage	pin open-circuit	[2] 200	300	360	mV
$f_{-3dB(u)}$	upper cut-off frequency		[2] 4	8	12	MHz
$I_{bias(int)}$	internal bias current (DC)	of emitter follower	[2] 150	200	-	μA
$I_{sink(o)(max)}$	maximum output sink current	AC and DC	[2] 100	-	-	μA
$I_{source(o)(max)}$	maximum output source current	AC and DC; with resistor to GND	[2][10] 430	-	-	μA

- [1] Some parameters can be decreased at  $V_P = 4.5\text{ V}$ .
- [2] This parameter is not tested during production and is only given as application information.
- [3] Output current can be increased by application of single-ended resistor from each output pin to GND. Recommended resistor value is minimum 1 kΩ.
- [4] With single-ended load for  $f_{IF} < 45\text{ MHz}$   $R_L \geq 1\text{ k}\Omega$  and  $C_L \leq 5\text{ pF}$  to ground and for  $f_{IF} = 45\text{ MHz}$  to 60 MHz  $R_L = 1\text{ k}\Omega$  and  $C_L \leq 3\text{ pF}$  to ground.
- [5] Noise level is measured without input signal but AGC adjusted corresponding to the given input level.
- [6] Set with AGC nominal output voltage as reference. For C/N measurement switch input signal off.
- [7] With single-ended load  $R_L \geq 1\text{ k}\Omega$  and  $C_L \leq 5\text{ pF}$  to ground.
- [8] The tolerance of the reference frequency determines the accuracy of VIF AFC, RIF AFC, FM demodulator center frequency, maximum FM deviation, sound trap frequency, LIF band-pass cut-off frequency and ZIF low-pass cut-off frequency as well as the accuracy of the synthesizer.
- [9] The value of  $C_{pull}$  determines the accuracy of the resonance frequency of the crystal. It depends on the used type of crystal.
- [10] For driving three reference frequency inputs via decoupling capacitors in parallel (three times TDA9899, pin FREF, W7[7] = 0) and a single-ended capacitive load up to 6.5 pF the recommended value of the resistor to GND is 10 kΩ.

**Table 59. Conversion synthesizer PLL; loop filter dimensions<sup>[1]</sup>**

$f_{VCO}$ (MHz)	$R_{LFSYN2}$ (k $\Omega$ ) <sup>[2]</sup>	$C_{LFSYN2}$ (nF)
22 to 29.5	1.5	4.7
30 to 37.5	1.8	4.7
38 to 45.5	2.2	4.7
46 to 53.5	2.7	4.7
57	3.3	4.7

[1] Calculation of the PLL loop filter by using the following formulae, valid under the condition for the damping

factor  $d \geq 1.2$ .  $B_{LF(-3dB)} = \frac{K_O}{N} K_D R_{LFSYN2}$  and  $d = \frac{1}{2} R_{LFSYN2} \sqrt{2\pi \frac{K_O}{N} K_D C_{LFSYN2}}$  with the following parameters

$K_O$  = VCO steepness (MHz/V),

$N$  = divider ratio:  $N = \frac{f_{VCO}}{0.5 \text{ MHz}}$ ,

$K_D$  = phase frequency detector steepness ( $\mu\text{A/rad}$ ),

$R_{LFSYN2}$  = synthesizer loop filter serial resistor ( $\Omega$ ),

$C_{LFSYN2}$  = synthesizer loop filter serial capacitor (F),

$B_{LF(-3dB)}$  = -3 dB LF bandwidth (Hz),

$d$  = damping factor.

[2] If more than one frequency range is used in the application, then the smallest resistor value should be applied.

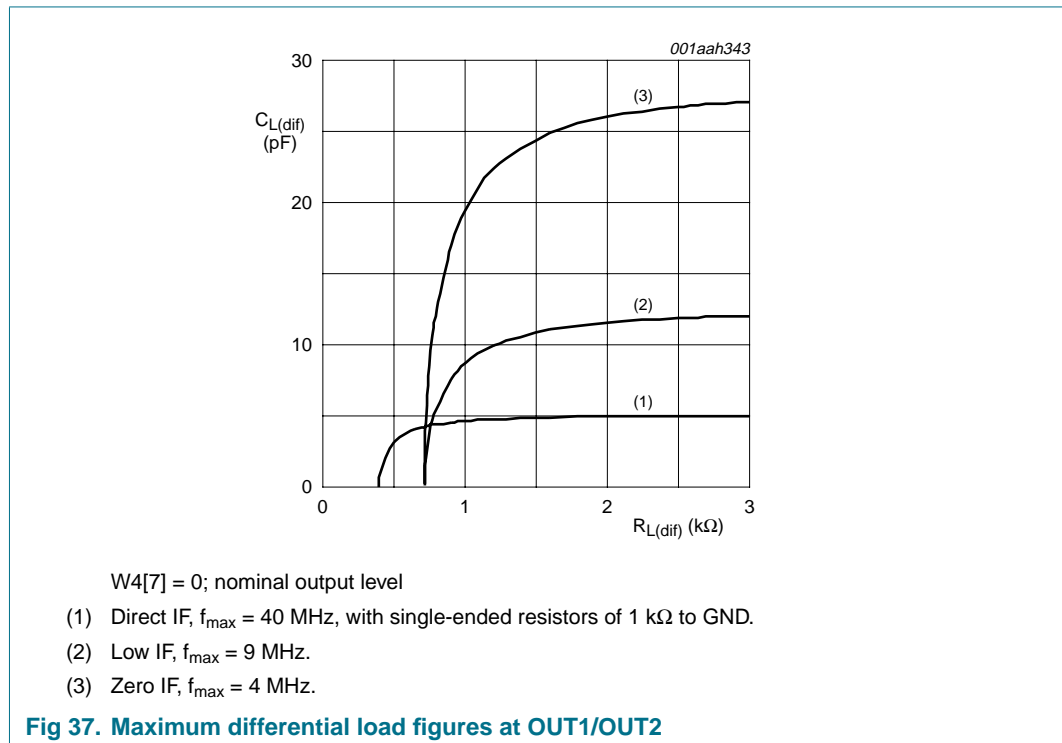

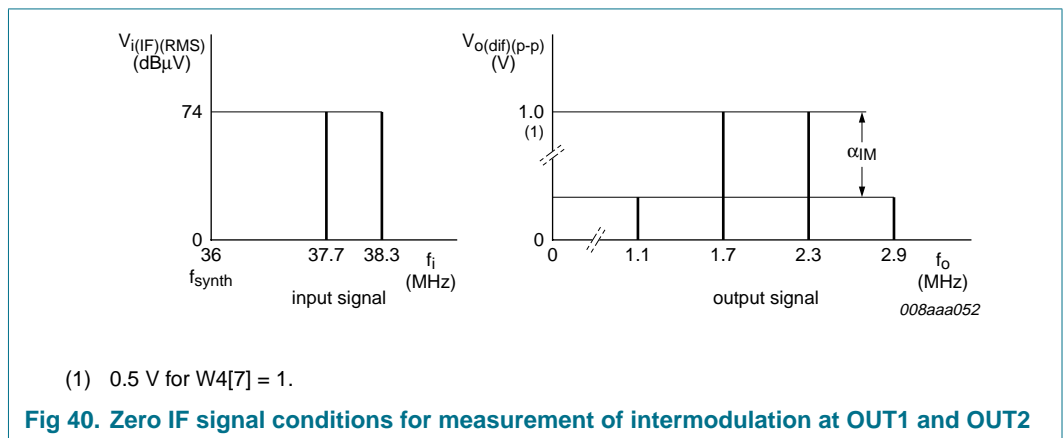
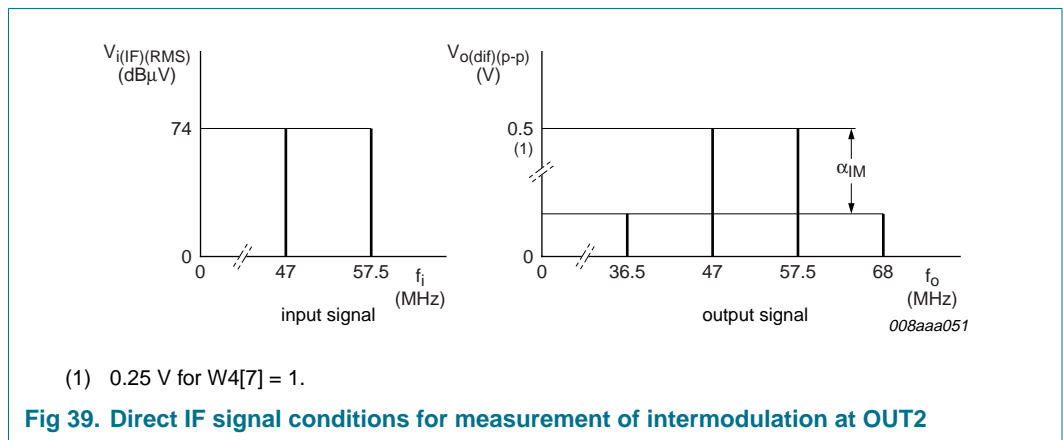
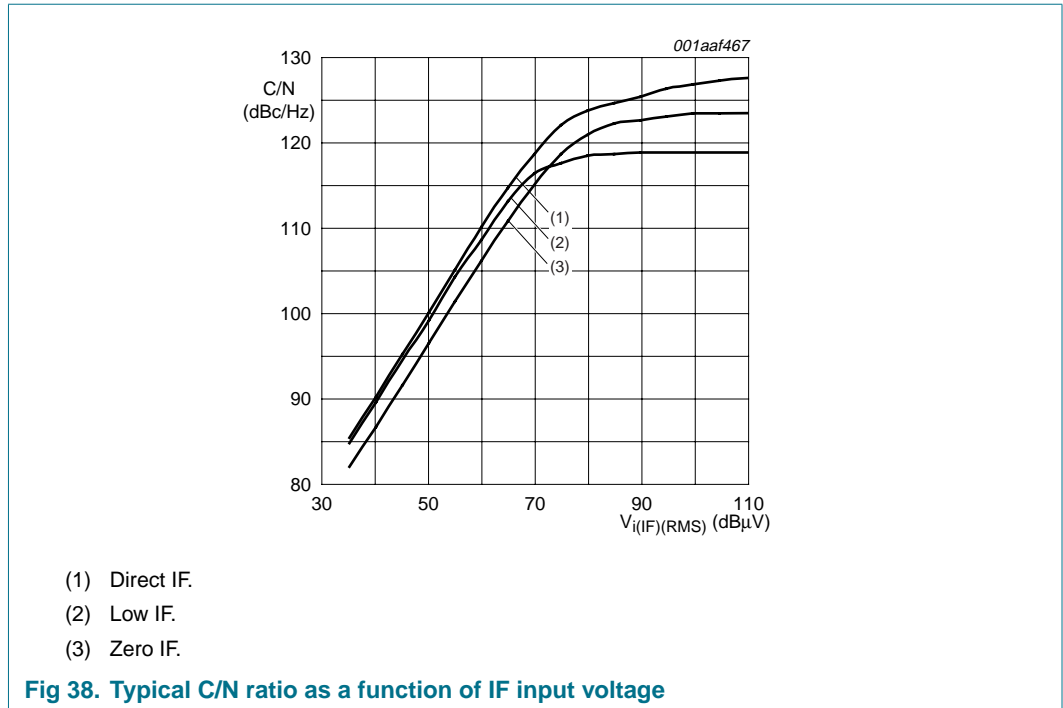



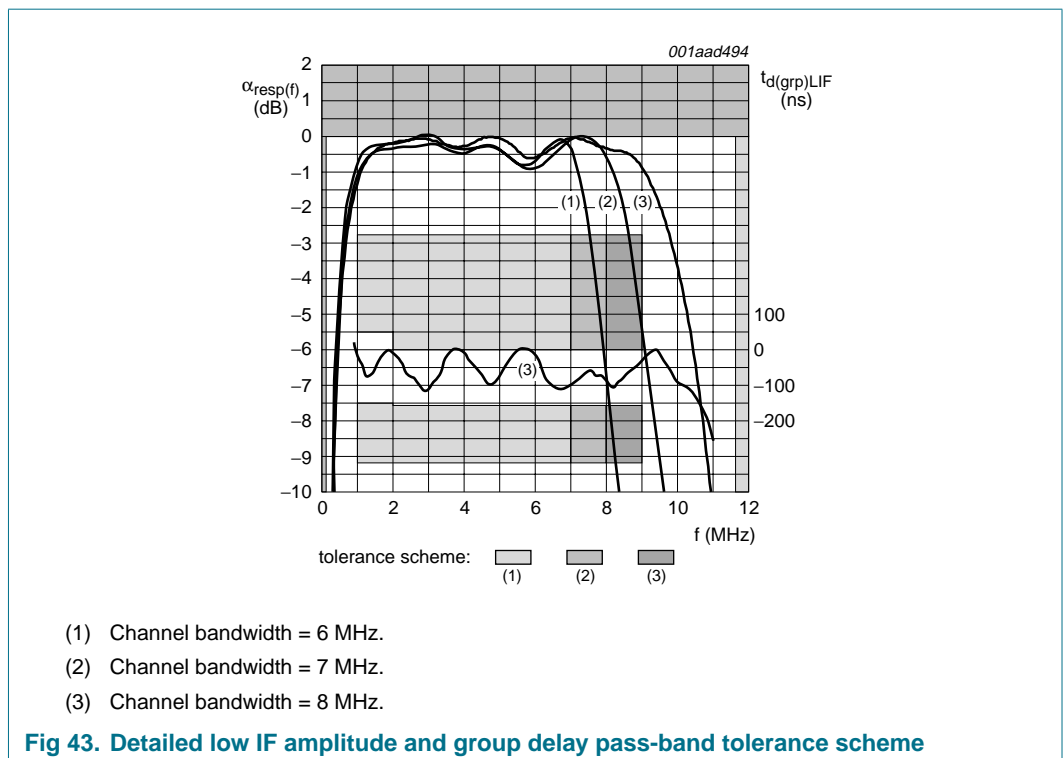
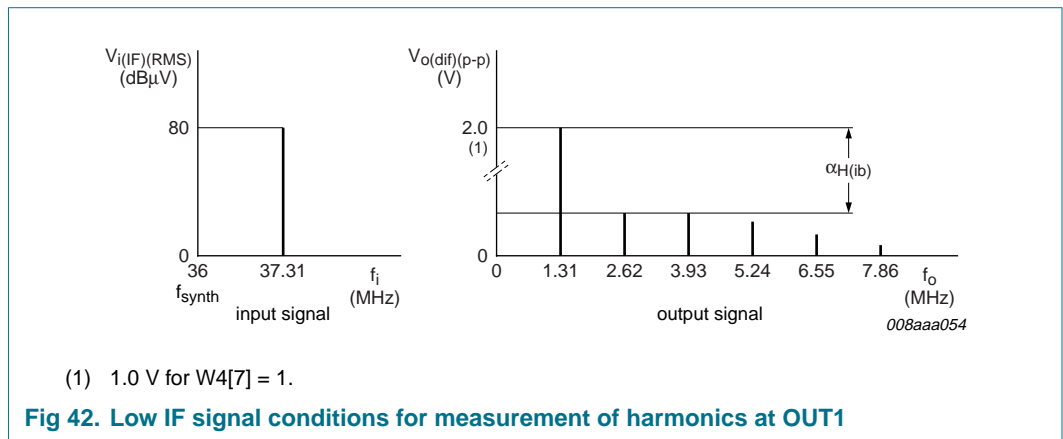
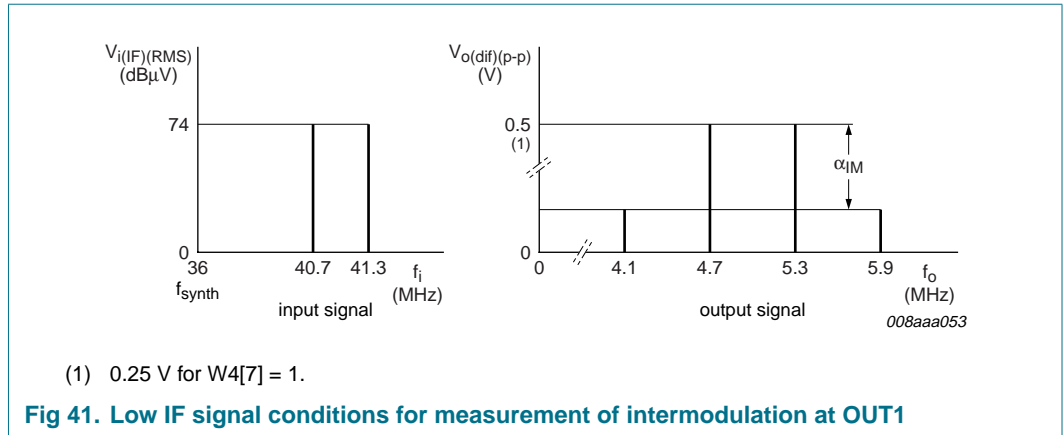

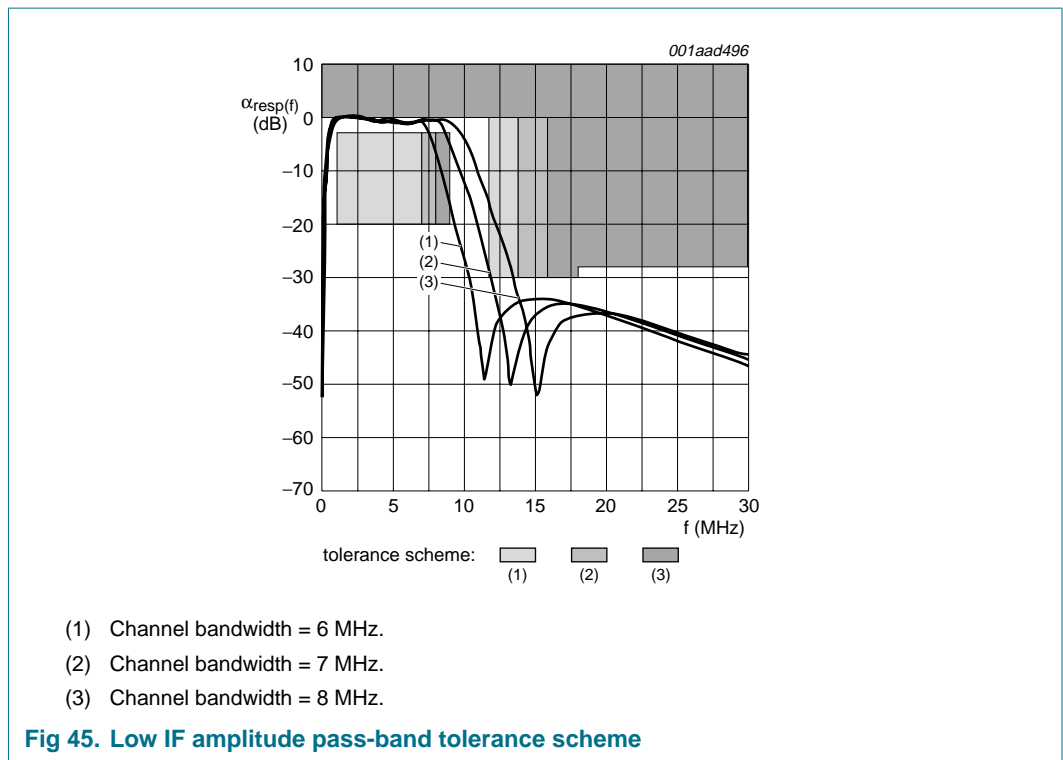
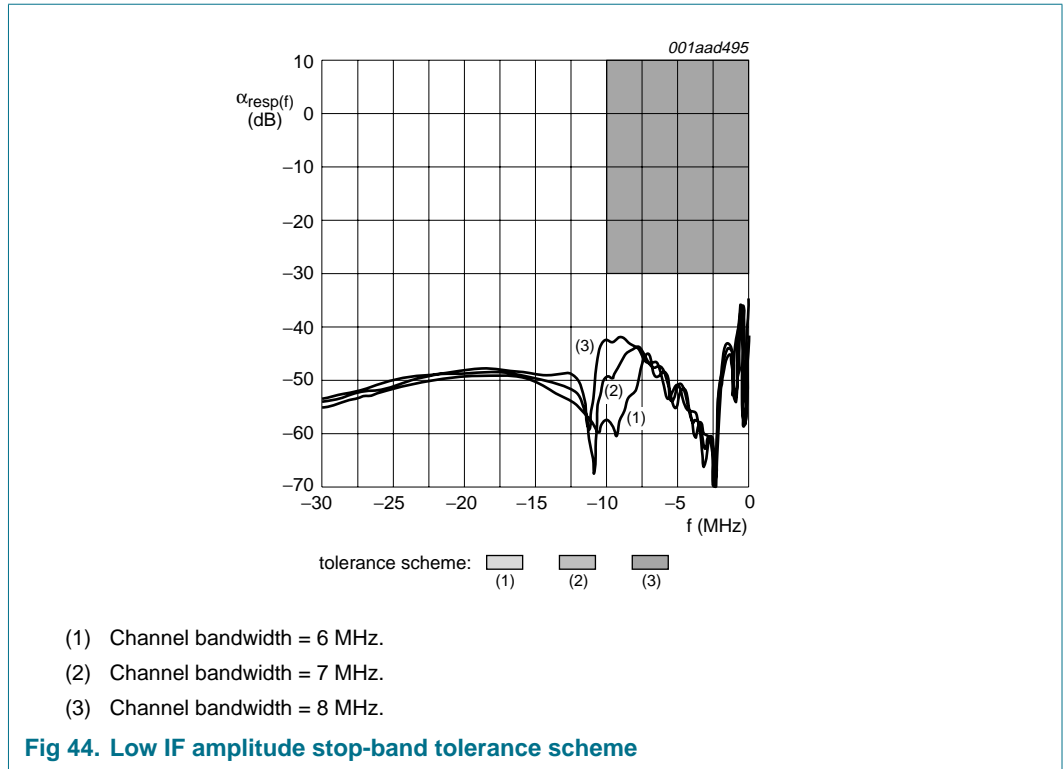

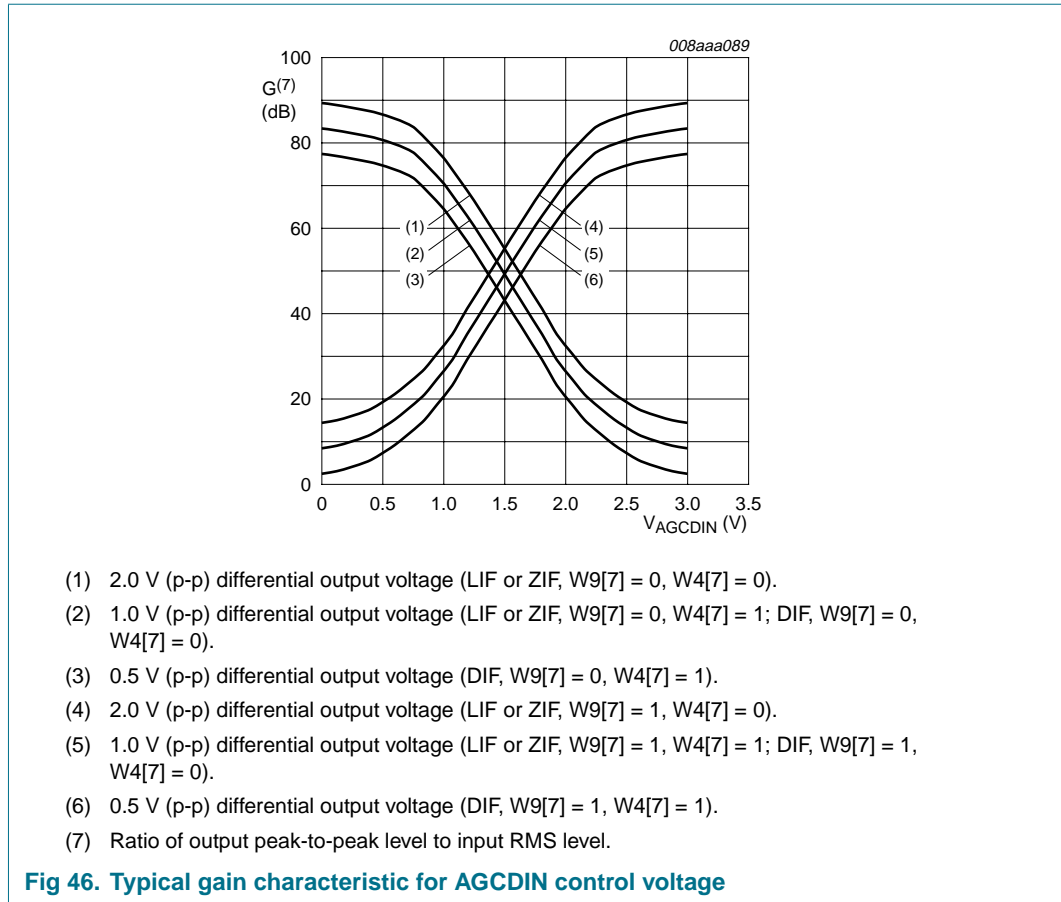

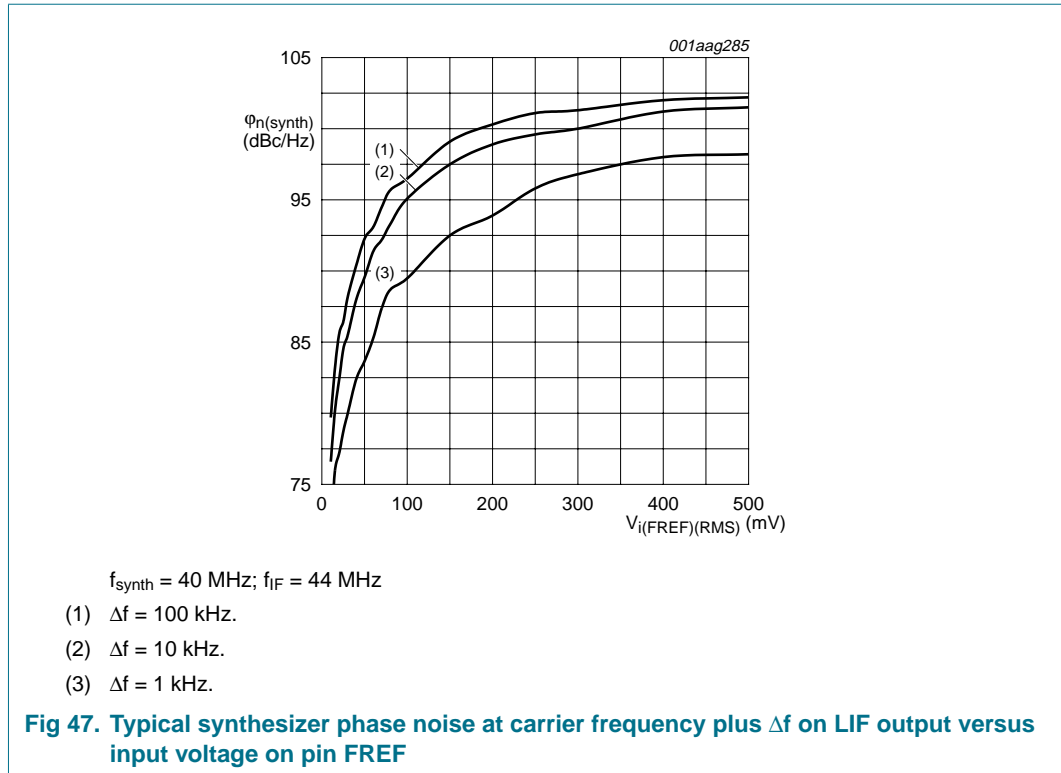

13. Application information

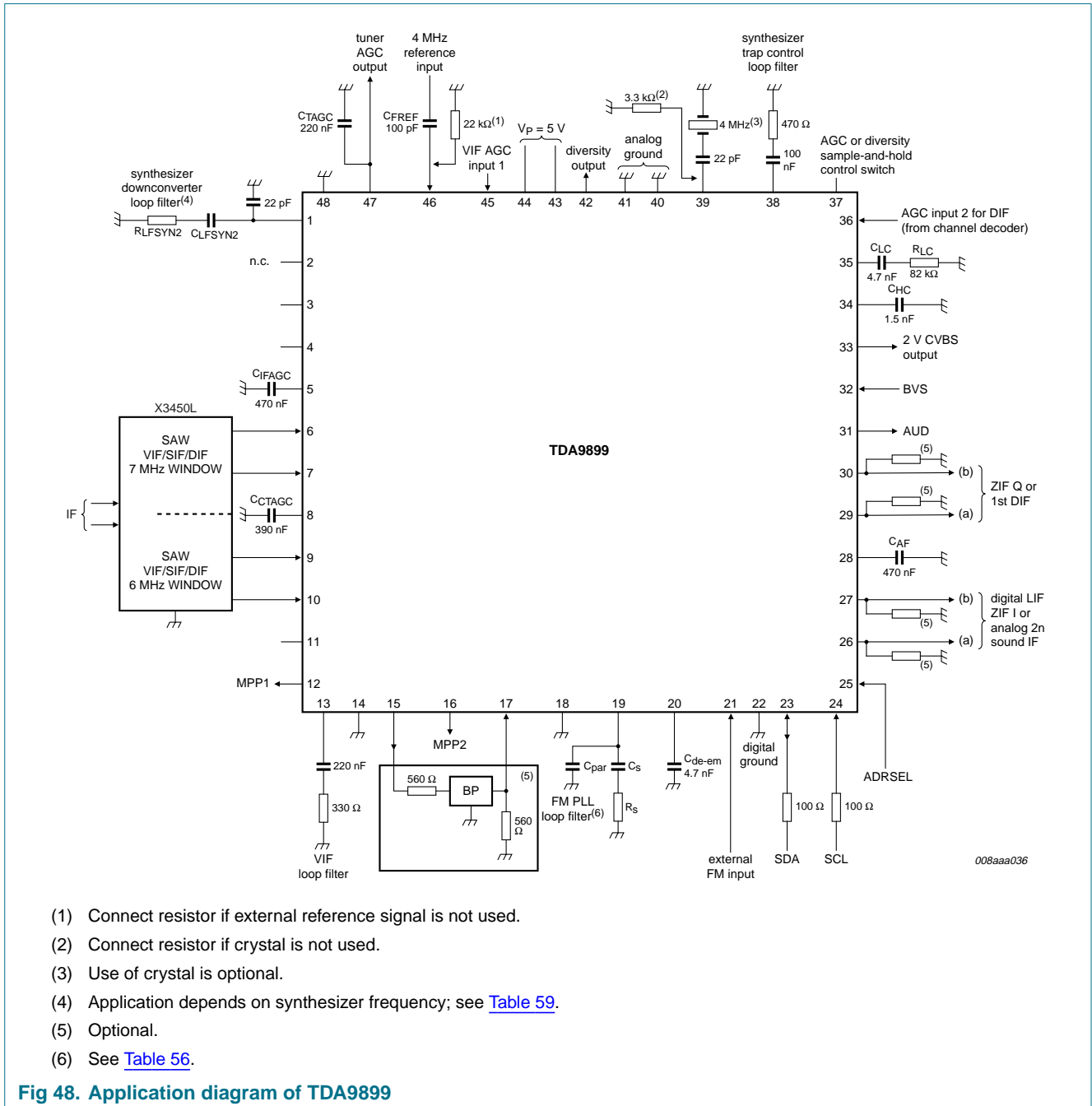

- (1) Connect resistor if external reference signal is not used.
- (2) Connect resistor if crystal is not used.
- (3) Use of crystal is optional.
- (4) Application depends on synthesizer frequency; see Table 59.
- (5) Optional.
- (6) See Table 56.

Fig 48. Application diagram of TDA9899

14. Test information

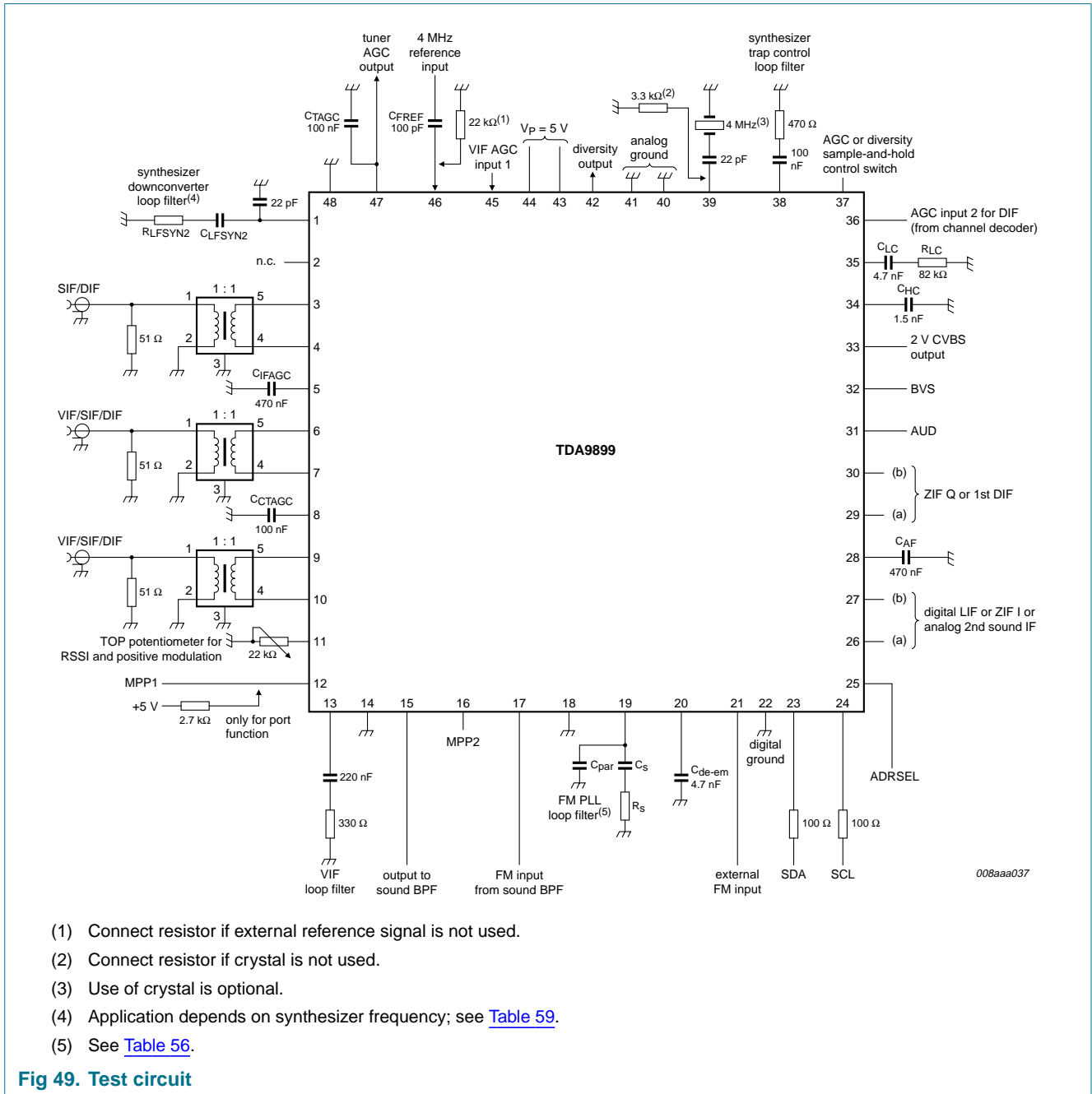

- (1) Connect resistor if external reference signal is not used.
- (2) Connect resistor if crystal is not used.
- (3) Use of crystal is optional.
- (4) Application depends on synthesizer frequency; see [Table 59](#).
- (5) See [Table 56](#).

Fig 49. Test circuit

15. Package outline

LQFP48: plastic low profile quad flat package; 48 leads; body 7 x 7 x 1.4 mm

SOT313-2

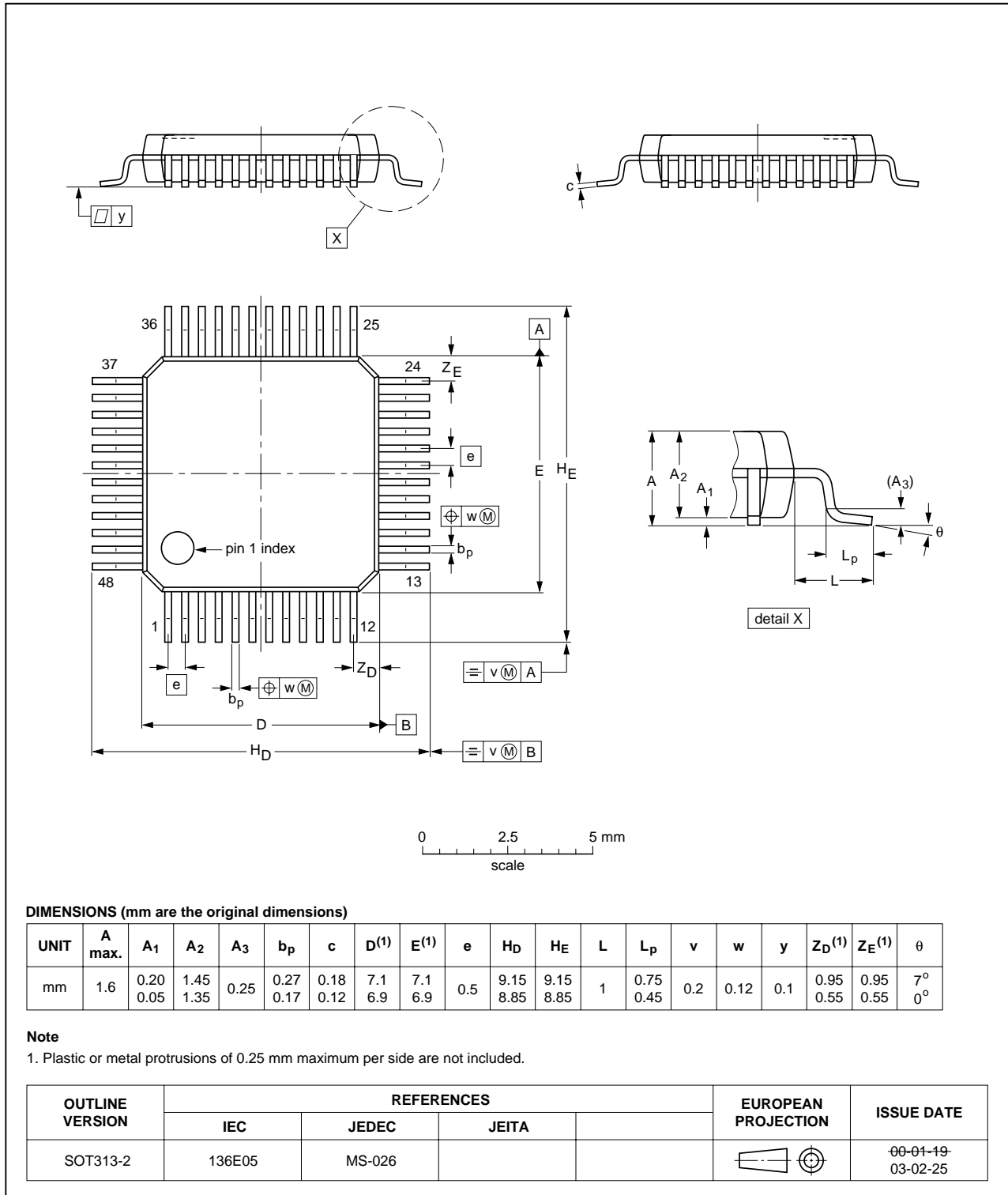

Fig 50. Package outline SOT313-2 (LQFP48)

HVQFN48: plastic thermal enhanced very thin quad flat package; no leads; 48 terminals; body 7 x 7 x 0.85 mm

SOT619-1

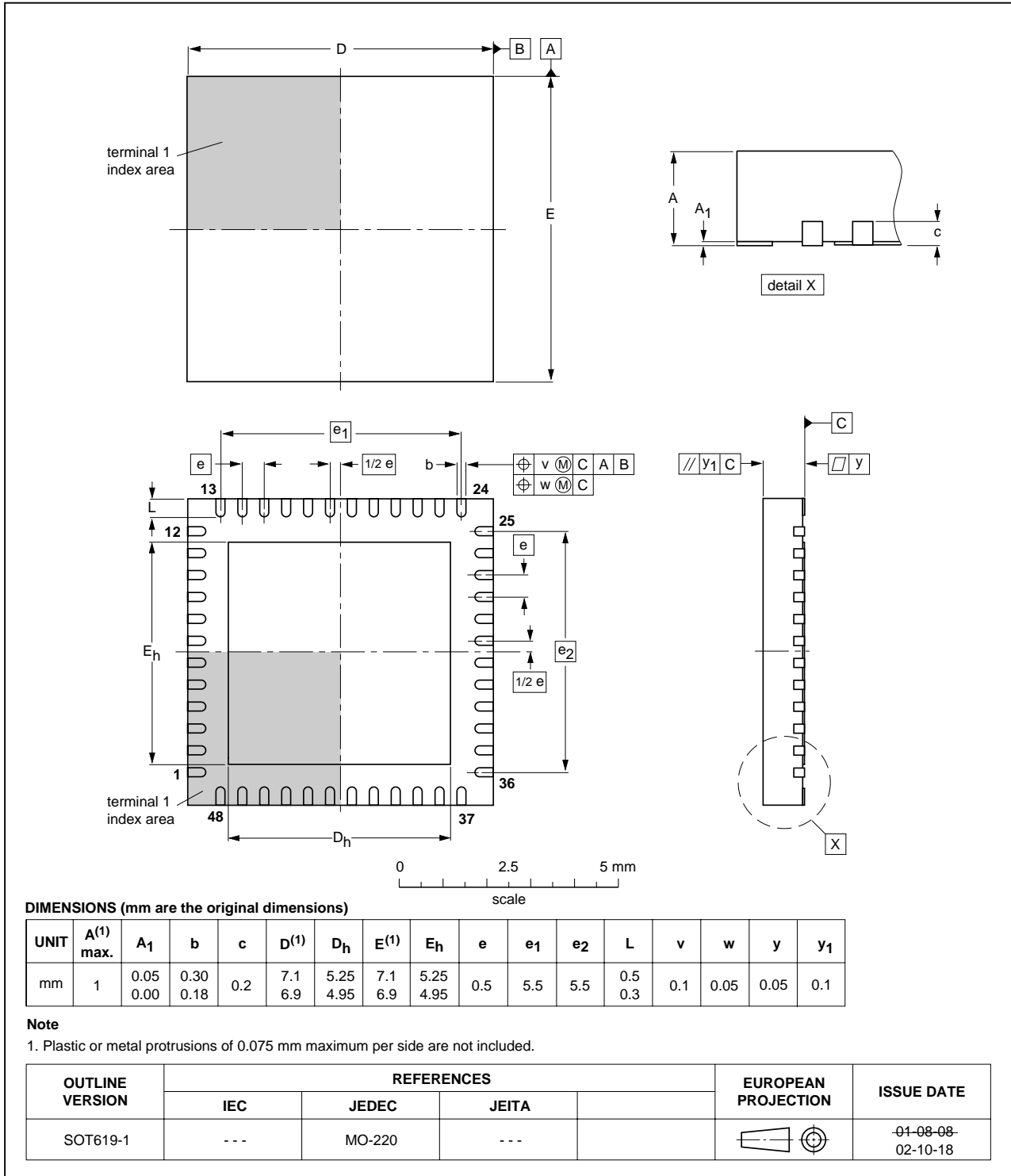

Fig 51. Package outline SOT619-1 (HVQFN48)



## 16. Soldering

### 16.1 Introduction

There is no soldering method that is ideal for all surface mount IC packages. Wave soldering can still be used for certain surface mount ICs, but it is not suitable for fine pitch SMDs. In these situations reflow soldering is recommended.

### 16.2 Through-hole mount packages

#### 16.2.1 Soldering by dipping or by solder wave

Typical dwell time of the leads in the wave ranges from 3 seconds to 4 seconds at 250 °C or 265 °C, depending on solder material applied, SnPb or Pb-free respectively.

The total contact time of successive solder waves must not exceed 5 seconds.

The device may be mounted up to the seating plane, but the temperature of the plastic body must not exceed the specified maximum storage temperature ( $T_{stg(max)}$ ). If the printed-circuit board has been pre-heated, forced cooling may be necessary immediately after soldering to keep the temperature within the permissible limit.

#### 16.2.2 Manual soldering

Apply the soldering iron (24 V or less) to the lead(s) of the package, either below the seating plane or not more than 2 mm above it. If the temperature of the soldering iron bit is less than 300 °C it may remain in contact for up to 10 seconds. If the bit temperature is between 300 °C and 400 °C, contact may be up to 5 seconds.

### 16.3 Surface mount packages

#### 16.3.1 Reflow soldering

Key characteristics in reflow soldering are:

- Lead-free versus SnPb soldering; note that a lead-free reflow process usually leads to higher minimum peak temperatures (see [Figure 52](#)) than a PbSn process, thus reducing the process window
- Solder paste printing issues including smearing, release, and adjusting the process window for a mix of large and small components on one board
- Reflow temperature profile; this profile includes preheat, reflow (in which the board is heated to the peak temperature) and cooling down. It is imperative that the peak temperature is high enough for the solder to make reliable solder joints (a solder paste characteristic). In addition, the peak temperature must be low enough that the packages and/or boards are not damaged. The peak temperature of the package depends on package thickness and volume and is classified in accordance with [Table 60](#) and [61](#)

**Table 60. SnPb eutectic process (from J-STD-020C)**

Package thickness (mm)	Package reflow temperature (°C)	
	Volume (mm <sup>3</sup> )	
	< 350	≥ 350
< 2.5	235	220
≥ 2.5	220	220

**Table 61. Lead-free process (from J-STD-020C)**

Package thickness (mm)	Package reflow temperature (°C)		
	Volume (mm <sup>3</sup> )		
	< 350	350 to 2000	> 2000
< 1.6	260	260	260
1.6 to 2.5	260	250	245
> 2.5	250	245	245

Moisture sensitivity precautions, as indicated on the packing, must be respected at all times.

Studies have shown that small packages reach higher temperatures during reflow soldering, see [Figure 52](#).

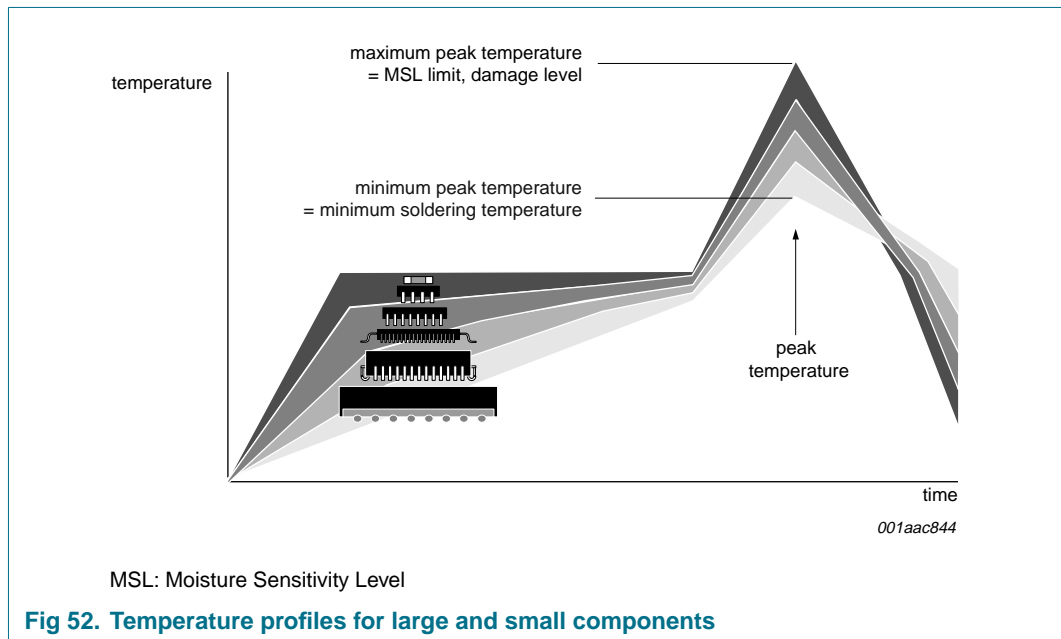

For further information on temperature profiles, refer to Application Note *AN10365 "Surface mount reflow soldering description"*.

**16.3.2 Wave soldering**

Conventional single wave soldering is not recommended for surface mount devices (SMDs) or printed-circuit boards with a high component density, as solder bridging and non-wetting can present major problems.

To overcome these problems the double-wave soldering method was specifically developed.

If wave soldering is used the following conditions must be observed for optimal results:

- Use a double-wave soldering method comprising a turbulent wave with high upward pressure followed by a smooth laminar wave.
- For packages with leads on two sides and a pitch (e):
  - larger than or equal to 1.27 mm, the footprint longitudinal axis is **preferred** to be parallel to the transport direction of the printed-circuit board;
  - smaller than 1.27 mm, the footprint longitudinal axis **must** be parallel to the transport direction of the printed-circuit board.

The footprint must incorporate solder thieves at the downstream end.

- For packages with leads on four sides, the footprint must be placed at a 45° angle to the transport direction of the printed-circuit board. The footprint must incorporate solder thieves downstream and at the side corners.

During placement and before soldering, the package must be fixed with a droplet of adhesive. The adhesive can be applied by screen printing, pin transfer or syringe dispensing. The package can be soldered after the adhesive is cured.

Typical dwell time of the leads in the wave ranges from 3 seconds to 4 seconds at 250 °C or 265 °C, depending on solder material applied, SnPb or Pb-free respectively.

A mildly-activated flux will eliminate the need for removal of corrosive residues in most applications.

### 16.3.3 Manual soldering

Fix the component by first soldering two diagonally-opposite end leads. Use a low voltage (24 V or less) soldering iron applied to the flat part of the lead. Contact time must be limited to 10 seconds at up to 300 °C.

When using a dedicated tool, all other leads can be soldered in one operation within 2 seconds to 5 seconds between 270 °C and 320 °C.

## 16.4 Package related soldering information

Table 62. Suitability of IC packages for wave, reflow and dipping soldering methods

Mounting	Package <sup>[1]</sup>	Soldering method		
		Wave	Reflow <sup>[2]</sup>	Dipping
Through-hole mount	CPGA, HCPGA	suitable	–	–
	DBS, DIP, HDIP, RDBS, SDIP, SIL	suitable <sup>[3]</sup>	–	suitable
Through-hole-surface mount	PMFP <sup>[4]</sup>	not suitable	not suitable	–

**Table 62. Suitability of IC packages for wave, reflow and dipping soldering methods ...continued**

Mounting	Package <sup>[1]</sup>	Soldering method		
		Wave	Reflow <sup>[2]</sup>	Dipping
Surface mount	BGA, HTSSON..T <sup>[5]</sup> , LBGA, LFBGA, SQFP, SSOP..T <sup>[5]</sup> , TFBGA, VFBGA, XSON	not suitable	suitable	–
	DHVQFN, HBCC, HBGA, HLQFP, HSO, HSOP, HSQFP, HSSON, HTQFP, HTSSOP, HVQFN, HVSON, SMS	not suitable <sup>[6]</sup>	suitable	–
	PLCC <sup>[7]</sup> , SO, SOJ	suitable	suitable	–
	LQFP, QFP, TQFP	not recommended <sup>[7][8]</sup>	suitable	–
	SSOP, TSSOP, VSO, VSSOP	not recommended <sup>[9]</sup>	suitable	–
	CWQCCN..L <sup>[10]</sup> , WQCCN..L <sup>[10]</sup>	not suitable	not suitable	–

- [1] For more detailed information on the BGA packages refer to the *(LF)BGA Application Note (AN01026)*; order a copy from your NXP Semiconductors sales office.
- [2] All surface mount (SMD) packages are moisture sensitive. Depending upon the moisture content, the maximum temperature (with respect to time) and body size of the package, there is a risk that internal or external package cracks may occur due to vaporization of the moisture in them (the so called popcorn effect).
- [3] For SDIP packages, the longitudinal axis must be parallel to the transport direction of the printed-circuit board.
- [4] Hot bar soldering or manual soldering is suitable for PMFP packages.
- [5] These transparent plastic packages are extremely sensitive to reflow soldering conditions and must on no account be processed through more than one soldering cycle or subjected to infrared reflow soldering with peak temperature exceeding 217 °C ± 10 °C measured in the atmosphere of the reflow oven. The package body peak temperature must be kept as low as possible.
- [6] These packages are not suitable for wave soldering. On versions with the heatsink on the bottom side, the solder cannot penetrate between the printed-circuit board and the heatsink. On versions with the heatsink on the top side, the solder might be deposited on the heatsink surface.
- [7] If wave soldering is considered, then the package must be placed at a 45° angle to the solder wave direction. The package footprint must incorporate solder thieves downstream and at the side corners.
- [8] Wave soldering is suitable for LQFP, QFP and TQFP packages with a pitch (e) larger than 0.8 mm; it is definitely not suitable for packages with a pitch (e) equal to or smaller than 0.65 mm.
- [9] Wave soldering is suitable for SSOP, TSSOP, VSO and VSSOP packages with a pitch (e) equal to or larger than 0.65 mm; it is definitely not suitable for packages with a pitch (e) equal to or smaller than 0.5 mm.
- [10] Image sensor packages in principle should not be soldered. They are mounted in sockets or delivered pre-mounted on flex foil. However, the image sensor package can be mounted by the client on a flex foil by using a hot bar soldering process. The appropriate soldering profile can be provided on request.

## 17. Abbreviations

**Table 63. Abbreviations**

Acronym	Description
ADC	Analog-to-Digital Converter
AFC	Automatic Frequency Control
AGC	Automatic Gain Control
ATV	Analog TV
BP	Band-Pass
CW	Continuous Wave
DAC	Digital-to-Analog Converter
DC	Direct Current

Table 63. Abbreviations ...continued

Acronym	Description
DIF	Digital Intermediate Frequency
DSP	Digital Signal Processor
DTV	Digital TV
DVB	Digital Video Broadcast
ESD	ElectroStatic Discharge
FPLL	Frequency Phase-Locked Loop
IC	Integrated Circuit
IF	Intermediate Frequency
LCD	Liquid Crystal Display
LIF	Low Intermediate Frequency
MAD	Module Address
NICAM	Near Instantaneous Companded Audio Multiplex
PLL	Phase-Locked Loop
QSS	Quasi Split Sound
RIF	Radio Intermediate Frequency
RSSI	Received Signal Strength Indication
SAW	Surface Acoustic Wave
SC	Sound Carrier
SIF	Sound Intermediate Frequency
TAGC	Tuner Automatic Gain Control
TOP	TakeOver Point
TSS	True Split Sound
VCO	Voltage-Controlled Oscillator
VIF	Vision Intermediate Frequency
VITS	Vertical Interval Test Signal
WAFP	Weak Audio Frequency Processing
ZIF	Zero Intermediate Frequency

## 18. Revision history

Table 64. Revision history

Document ID	Release date	Data sheet status	Change notice	Supersedes
TDA9899_3	20080115	Product data sheet	-	TDA9899_2
Modifications:	<ul style="list-style-type: none"> <li>Additional specification of features for V2 version</li> </ul>			
TDA9899_2	20070208	Product data sheet	-	TDA9899HL_ TDA9899HN_1
TDA9899HL_ TDA9899HN_1	20060925	Product data sheet	-	-

## 19. Legal information

### 19.1 Data sheet status

Document status <sup>[1][2]</sup>	Product status <sup>[3]</sup>	Definition
Objective [short] data sheet	Development	This document contains data from the objective specification for product development.
Preliminary [short] data sheet	Qualification	This document contains data from the preliminary specification.
Product [short] data sheet	Production	This document contains the product specification.

[1] Please consult the most recently issued document before initiating or completing a design.

[2] The term 'short data sheet' is explained in section "Definitions".

[3] The product status of device(s) described in this document may have changed since this document was published and may differ in case of multiple devices. The latest product status information is available on the Internet at URL <http://www.nxp.com>.

### 19.2 Definitions

**Draft** — The document is a draft version only. The content is still under internal review and subject to formal approval, which may result in modifications or additions. NXP Semiconductors does not give any representations or warranties as to the accuracy or completeness of information included herein and shall have no liability for the consequences of use of such information.

**Short data sheet** — A short data sheet is an extract from a full data sheet with the same product type number(s) and title. A short data sheet is intended for quick reference only and should not be relied upon to contain detailed and full information. For detailed and full information see the relevant full data sheet, which is available on request via the local NXP Semiconductors sales office. In case of any inconsistency or conflict with the short data sheet, the full data sheet shall prevail.

### 19.3 Disclaimers

**General** — Information in this document is believed to be accurate and reliable. However, NXP Semiconductors does not give any representations or warranties, expressed or implied, as to the accuracy or completeness of such information and shall have no liability for the consequences of use of such information.

**Right to make changes** — NXP Semiconductors reserves the right to make changes to information published in this document, including without limitation specifications and product descriptions, at any time and without notice. This document supersedes and replaces all information supplied prior to the publication hereof.

**Suitability for use** — NXP Semiconductors products are not designed, authorized or warranted to be suitable for use in medical, military, aircraft, space or life support equipment, nor in applications where failure or malfunction of an NXP Semiconductors product can reasonably be expected

to result in personal injury, death or severe property or environmental damage. NXP Semiconductors accepts no liability for inclusion and/or use of NXP Semiconductors products in such equipment or applications and therefore such inclusion and/or use is at the customer's own risk.

**Applications** — Applications that are described herein for any of these products are for illustrative purposes only. NXP Semiconductors makes no representation or warranty that such applications will be suitable for the specified use without further testing or modification.

**Limiting values** — Stress above one or more limiting values (as defined in the Absolute Maximum Ratings System of IEC 60134) may cause permanent damage to the device. Limiting values are stress ratings only and operation of the device at these or any other conditions above those given in the Characteristics sections of this document is not implied. Exposure to limiting values for extended periods may affect device reliability.

**Terms and conditions of sale** — NXP Semiconductors products are sold subject to the general terms and conditions of commercial sale, as published at <http://www.nxp.com/profile/terms>, including those pertaining to warranty, intellectual property rights infringement and limitation of liability, unless explicitly otherwise agreed to in writing by NXP Semiconductors. In case of any inconsistency or conflict between information in this document and such terms and conditions, the latter will prevail.

**No offer to sell or license** — Nothing in this document may be interpreted or construed as an offer to sell products that is open for acceptance or the grant, conveyance or implication of any license under any copyrights, patents or other industrial or intellectual property rights.

### 19.4 Trademarks

Notice: All referenced brands, product names, service names and trademarks are the property of their respective owners.

**I<sup>2</sup>C-bus** — logo is a trademark of NXP B.V.

## 20. Contact information

For additional information, please visit: <http://www.nxp.com>

For sales office addresses, send an email to: [salesaddresses@nxp.com](mailto:salesaddresses@nxp.com)

## 21. Contents

<b>1</b>	<b>General description</b> . . . . .	<b>1</b>	16.1	Introduction . . . . .	97
<b>2</b>	<b>Features</b> . . . . .	<b>1</b>	16.2	Through-hole mount packages . . . . .	97
2.1	General . . . . .	1	16.2.1	Soldering by dipping or by solder wave . . . . .	97
2.2	Analog TV processing . . . . .	1	16.2.2	Manual soldering . . . . .	97
2.3	Digital TV processing . . . . .	2	16.3	Surface mount packages . . . . .	97
2.4	Dual mode . . . . .	3	16.3.1	Reflow soldering . . . . .	97
2.5	FM radio mode . . . . .	3	16.3.2	Wave soldering . . . . .	98
<b>3</b>	<b>Applications</b> . . . . .	<b>3</b>	16.3.3	Manual soldering . . . . .	99
<b>4</b>	<b>Quick reference data</b> . . . . .	<b>3</b>	16.4	Package related soldering information . . . . .	99
<b>5</b>	<b>Ordering information</b> . . . . .	<b>7</b>	<b>17</b>	<b>Abbreviations</b> . . . . .	<b>100</b>
<b>6</b>	<b>Block diagram</b> . . . . .	<b>8</b>	<b>18</b>	<b>Revision history</b> . . . . .	<b>101</b>
<b>7</b>	<b>Pinning information</b> . . . . .	<b>10</b>	<b>19</b>	<b>Legal information</b> . . . . .	<b>102</b>
7.1	Pinning . . . . .	10	19.1	Data sheet status . . . . .	102
7.2	Pin description . . . . .	11	19.2	Definitions . . . . .	102
<b>8</b>	<b>Functional description</b> . . . . .	<b>12</b>	19.3	Disclaimers . . . . .	102
8.1	IF input switch . . . . .	12	19.4	Trademarks . . . . .	102
8.2	VIF demodulator . . . . .	13	<b>20</b>	<b>Contact information</b> . . . . .	<b>102</b>
8.3	VIF AGC and tuner AGC . . . . .	13	<b>21</b>	<b>Contents</b> . . . . .	<b>103</b>
8.3.1	Mode selection of VIF AGC . . . . .	13			
8.3.2	External VIF AGC control . . . . .	13			
8.3.3	VIF AGC monitor . . . . .	13			
8.3.4	Tuner AGC . . . . .	14			
8.4	DIF/SIF FM and AM sound AGC . . . . .	14			
8.5	Frequency phase-locked loop for VIF . . . . .	14			
8.6	DIF/SIF converter stage . . . . .	15			
8.7	Mono sound demodulator . . . . .	15			
8.7.1	Narrow-band FM PLL demodulation . . . . .	15			
8.7.2	AM sound demodulation . . . . .	15			
8.8	Audio amplifier . . . . .	15			
8.9	Synthesizer . . . . .	16			
8.10	I <sup>2</sup> C-bus transceiver and slave address . . . . .	16			
<b>9</b>	<b>I<sup>2</sup>C-bus control</b> . . . . .	<b>16</b>			
9.1	Read format . . . . .	17			
9.2	Write format . . . . .	20			
9.2.1	Subaddress . . . . .	21			
9.2.2	Description of data bytes . . . . .	22			
<b>10</b>	<b>Limiting values</b> . . . . .	<b>36</b>			
<b>11</b>	<b>Thermal characteristics</b> . . . . .	<b>36</b>			
<b>12</b>	<b>Characteristics</b> . . . . .	<b>36</b>			
12.1	Analog TV signal processing . . . . .	36			
12.2	Digital TV signal processing . . . . .	79			
<b>13</b>	<b>Application information</b> . . . . .	<b>93</b>			
<b>14</b>	<b>Test information</b> . . . . .	<b>94</b>			
<b>15</b>	<b>Package outline</b> . . . . .	<b>95</b>			
<b>16</b>	<b>Soldering</b> . . . . .	<b>97</b>			

Please be aware that important notices concerning this document and the product(s) described herein, have been included in section 'Legal information'.

founded by

**PHILIPS**

© NXP B.V. 2008.

All rights reserved.

For more information, please visit: <http://www.nxp.com>

For sales office addresses, please send an email to: [salesaddresses@nxp.com](mailto:salesaddresses@nxp.com)

Date of release: 15 January 2008

Document identifier: TDA9899\_3